

LIFT PORT

ELEVATOR SYSTEMS



Catalogue
2021



EXPORT

LIFT PORT
ELEVATOR SYSTEMS

discover

TECHNOLOGY

www.liftport.com.tr

IMPORT

EN

Orpan Elektrik has managed to take its place among the biggest suppliers of the electricity sector, with the knowledge and experience gained for many years, the principles it has adopted since the day it was founded, and the distributorships of leading brands.

In 2017, we decided to invest in control panels and components in the elevator industry, and our new company started operations with the Panoma brand. It produces approximately 10,000 elevator control panels and components per year.

We have made a new investment in the elevator industry with the LIFTPORT brand, as a result of the demands of our customers in panel, cabin, automatic door, complete elevator systems with the experience we have gained in the elevator industry for many years. With its solution partners who have been pioneers in the sector, it continues its efforts and investments to become the leader and most preferred brand in the field of import and export in the elevator sector.

RU

Orpan Elektrik удалось занять свое место среди крупнейших поставщиков в электроэнергетическом секторе благодаря знаниям и опыту, накопленным за многие годы, принципам, которые компания придерживается со дня своего основания, а также дистрибьюторам ведущих брендов.

В 2017 году мы решили инвестировать в панели управления и компоненты в лифтовой отрасли, и наша новая компания начала работать с брендом Panoma. Она производит около 10 000 панелей управления и компонентов лифтов в год.

Мы сделали новые инвестиции в лифтовую промышленность с брендом LIFTPORT в результате требований наших клиентов к панельным, кабинам, автоматическим дверям, комплексным лифтовым системам с опытом, который мы накопили в лифтовой отрасли за многие годы. Вместе со своими партнерами по решениям, которые были пионерами в этом секторе, компания продолжает свои усилия и инвестиции, чтобы стать лидером и наиболее предпочтительным брендом в области импорта и экспорта в лифтовом секторе.

TR

Orpan Elektrik, olarak başlanılan ticari hayatta, Uzun yıllardır elde edilen birikim ve tecrübelerle, kurulduğu günden bu yana benimsediği ilkeleriyle ve lider markaların distribütörleriyle elektrik sektörünün en büyük tedarikçileri arasında yerini almayı başarmıştır.

2017 yılında asansör sektöründe kumanda panosu ve bileşenleri konusunda yatırım kararı olarak Panoma markası ile yeni firmamız faaliyete geçti. Yaklaşık olarak yılda 10.000 adet asansör kumanda panosu ve bileşenleri üretmektedir.

Asansör sektöründe uzun yıllardır elde etmiş olduğumuz tecrübeler ile pano, kabin, otomatik kapı, komple asansör sistemlerindeki müşterilerimizin talepleri sonucunda, LIFTPORT markası ile asansör sektörüne yeni bir yatırım gerçekleştirdik. Sektörde öncü olmuş çözüm ortaklarıyla asansör sektöründe ithalat ve ihracat alanında lider ve en çok tercih edilen marka olmaya yolunda çalışmalarına ve yatırımlarına devam etmektedir.

AR

تمكنت Orpan Elektrik من أن تأخذ مكانها بين أكبر موردي قطاع الكهرباء ، بالمعرفة والخبرة المكتسبة لسنوات عديدة ، والمبادئ التي اعتمدها منذ يوم تأسيسها ، وتعاملها مع العلامات التجارية الرائدة.

في عام 2017 ، قررنا الاستثمار في لوحات التحكم والمكونات الأخرى في صناعة المصاعد ، وبدأت شركتنا الجديدة عملياتها مع علامة Panoma التجارية. تنتج ما يقرب من 10000 لوحة تحكم في المصاعد سنويًا.

لقد قمنا باستثمار جديد في صناعة المصاعد بعلامة LIFTPORT التجارية ، كنتيجة لمتطلبات عملائنا فيما يتعلق بلوحات التحكم ، والكابن ، والأبواب الأوتوماتيكية ، وأنظمة المصاعد الكاملة مع الخبرة التي اكتسبناها في صناعة المصاعد لسنوات عديدة. تواصل جهودها واستثماراتها لتصبح العلامة التجارية الرائدة والأكثر تفضيلاً في مجال الاستيراد والتصدير في قطاع المصاعد مع شركائها الذين كانوا رواداً في هذا القطاع.

index

Содержание İçindekiler فهرس

Control Panels
Панели управления
Kumanda Panoları
لوحات تحكم



06-13

1

Cabin
Кабины
Kabinler
الكبائن



14-37

2

Doors
Двери
Kapılar
الابواب



41-43

3

Motor
Двигатель
Motor
محرك



46-48

4

Elevator Systems
Лифтовые системы
Asansör Sistemleri
أنظمة المصاعد

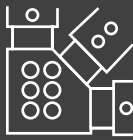

49-51

5

Options
Опции
Opsiyonlar
الخيارات الاضافية



52-56

6

Spare Parts
Запасные части
Yedek Parça
قطع الغيار



57-61

7

what's **INSIDE**...

IMPORT

EXPORT

The logo for ORPAN ELEKTRİK features a stylized graphic of three curved lines on the left, followed by the word "ORPAN" in a bold, sans-serif font where the "O" and "R" are grey and "PAN" is red. Below it, the word "ELEKTRİK" is written in a smaller, grey, sans-serif font.

ORPAN
ELEKTRİK

The logo for Panoma features a stylized yellow and black graphic on the left, followed by the word "Panoma" in a bold, italicized, black font with a registered trademark symbol. Below it, the text "Asansör Kontrol Sistemleri" is written in a smaller, black, sans-serif font.

Panoma®
Asansör Kontrol Sistemleri

The logo for LIFT PORT features the word "LIFT" in a bold, black, sans-serif font with a small teal triangle above the "I". To its right, the word "PORT" is written in white, bold, sans-serif font inside a teal rectangular box. Below both, the words "ELEVATOR SYSTEMS" are written in a smaller, black, sans-serif font.

LIFT PORT
ELEVATOR SYSTEMS



Control Panels | Панели управления
Kumanda Panoları | لوحات تحكم



ARKEL
PARTNER



ARCUBE
PARTNER

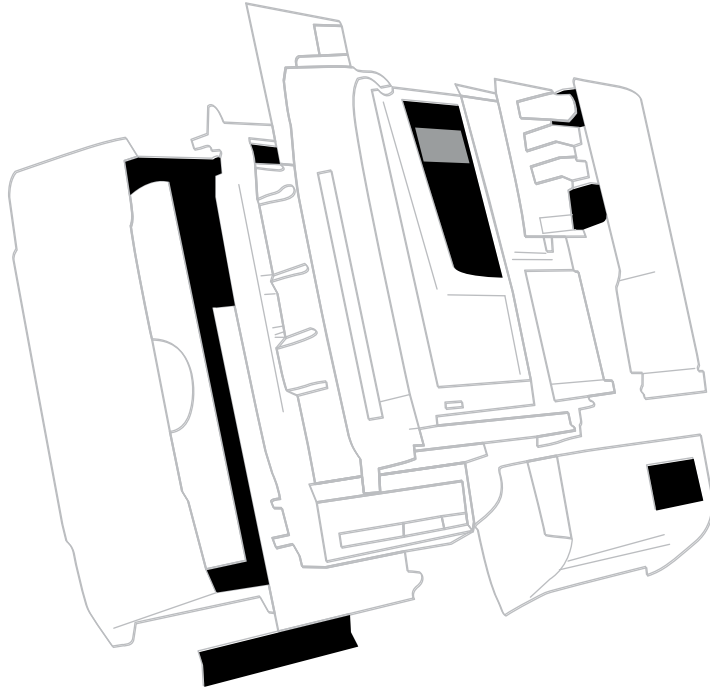

Monoblock Lift Control Unit
Моноблочный блок управления лифтом
Monoblok Asansör Kontrol Ünitesi
وحدة التحكم في الرفع أحادية الكتلة



Specifications | Характеристики | Özellikler | المواصفات

Number of Stops	16	Количество остановок	16	عدد المحطات	16		
Drive Type	Traction	Тип привода	Электрический	Tahrik tipi	Elektrikli	عملية النقل	سحب كهربائية
Car Positioning	Magnetic switches or motor encoder	Информация о положении	Через магнитные датчики или энкодер двигателя	Kabin Pozisyon Bilgisi	Manyetik şalter ya da motor enkoderi	وضع السيارة	مفاتيح مغناطيسية أو مشفر محرك
Door Bridging	Available	Защита от перемены двери	Имеется	Kapı Köprüleme	Mevcut	تجسير الباب	متوفرة
Models	7.5 kW (17A) & 11 kW (26A)	Модели	7,5 кВт (17 А) & 11 кВт (26 А)	Modeller	7.5 kW (17A) & 11 kW (26A)	الانواع	(كيلوواط 17 أمبير) و 11 كيلوواط (26 أمبير 7.5)
Control Type	Single Button Collective, Double Button Collective	Тип управления	Собираетельная вверх-вниз, собираетельная вниз	Kumanda Tipi	Tek Buton Toplama, Çift Buton Toplama	نوع التحكم	زر واحد جماعي ، زر مزدوج جماعي
Group Control	Duplex	Групповой контроль	Дуплекс	Grup Kumanda	Dubleks	التحكم في المجموعة	دوبلكس
Elevator Speed	1.75 m/s	Скорость лифта	1,75 м / с	Asansör Hızı	1.75 m/s	سرعة المصعد	م / ث 1.75
Motor Drive type	Contactless drive with STO function	Тип привода двигателя	Бесконтактный привод с функцией STO	Motor Sürme tipi	STO fonksiyonlu kontaktorsüz sürüş	نوع محرك المحرك	STO محرك بدون تلامس مع وظيفة
Compliance to Standards	EN 81-20	Соответствие стандартам	EN 81-20	Standartlara uygunluk	EN 81-20	الامتثال للمعايير	EN 81-20
Rollback Prevention	Rollback prevention at start through pre-torque and anti-rollback functions	Блокировка отката на старте	Предотвращение отката назад при старте с функциями удержания переднего крутящего момента на старте	Kalkış Tutma	Ön-tork ve kalkış tutma fonksiyonları ile kalkışta geri kaymayı önleme	منع التراجع في	منع التراجع تبدأ من خلال عزم الدوران المسبق ووظائف منع التراجع

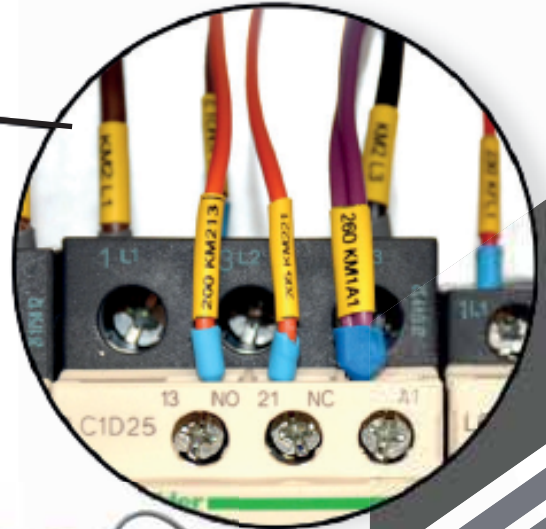

Specifications | Характеристики | Özellikler | المواصفات

Engine Control : Asynchronous Machinery	Контроль двигателя : асинхронное оборудование	Motor Kontrolü : Asenkron Makine	التحكم في المحرك : الآلات غير المتزامنة
Input Voltage (L1, L2, L3) : AC 3 Ph, 320-420V, 50/60 Hz	Входное напряжение (L1, L2, L3) : 3 фазы переменного тока, 320-420 В, 50/60 Гц	Giriş Gerilimi (L1, L2, L3) : AC 3 Ph, 320-420V, 50/60 Hz	جهود الإدخال (L1, L2, L3) : تيار متردد 3 فاه , 320-420 فولت , 50/60 هرتز
Models : ARCODE 14, 17, 26, 35, 50, 75A	Модели : АРКОД 14, 17, 26, 35, 50, 75А	Modeller : ARCODE 14, 17, 26, 35, 50, 75A	الانواع : ARCODE 14 , 17 , 26 , 35 , 50 , 75 أ
Speed : up to 4m/s	Скорость : до 4 м / с	Hız : 4m/s'ye kadar	سرعة : ما يصل إلى 4 م / ث
Group Study : Up to 8 elevators	Групповое исследование : До 8 лифтов	Grup Çalışma : 8 Asansöre kadar	مجموعة عمل : حتى 8 مصاعد
Number of Stops : up to 64 stops	Количество остановок : до 64 остановок	Durak Sayısı : 64 Durağa kadar	عدد المحطات : ما يصل إلى 64 توقف
Communication Protocol : CANbus	Протокол связи : CANbus	Haberleşme Protokolü : CANbus	نوع التواصل : كرت جان بوس
Encoder Options : 5V TTL, 10-30V HTL, EnDat, SSI, SinCos, BiSS	Параметры кодирования : 5 В TTL, 10-30 В HTL, EnDat, SSI, SinCos, BiSS	Encoder Opsiyonları : 5V TTL, 10-30V HTL, EnDat, SSI, SinCos, BiSS	خيارات التشفير : 5V TTL, 10-30V HTL, EnDat, SSI, SinCos, BiSS
Safety Circuit Voltage : 48 VAC - 250 VAC	Напряжение цепи безопасности : 48 В переменного тока - 250 В переменного тока	Güvenlik Devresi Gerilimi : 48 VAC - 250 VAC	جهود دائرة السلامة : 48 VAC - 250 VAC



Specifications | Характеристики | Özellikler | المواصفات

Engine Control	: Synchronous Machinery	Контроль двигателя	: Синхронное оборудование	Motor Kontrolü	: Senkron Makine	التحكم في المحرك	: الآلات المتزامنة
Input Voltage (L1, L2, L3)	: AC 3 Ph, 320-420V, 50/60 Hz	Входное напряжение (L1, L2, L3)	: 3 фазы переменного тока, 320-420 В, 50/60 Гц	Giriş Gerilimi (L1, L2, L3)	: AC 3 Ph, 320-420V, 50/60 Hz	جهد الإدخال (L1, L2, L3)	: تيار متردد 3 فاه , 320-420 فولت , 50/60 هرتز
Models	: ARCODE 14, 17, 26, 35, 50, 75A	Модели	: АРКОД 14, 17, 26, 35, 50, 75А	Modeller	: ARCODE 14, 17, 26, 35, 50, 75A	الانواع	: ARCODE 14 , 17 , 26 , 35 , 50 , 75 أ
Speed	: up to 4m/s	Скорость	: до 4 м / с	Hız	: 4m/s'ye kadar	سرعة	: ما يصل إلى 4 م / ث
Group Study	: Up to 8 elevators	Групповое исследование	: До 8 лифтов	Grup Çalışma	: 8 Asansöre kadar	مجموعة عمل	: حتى 8 مصاعد
Number of Stops	: up to 64 stops	Количество остановок	: до 64 остановок	Durak Sayısı	: 64 Durağa kadar	عدد المحطات	: ما يصل إلى 64 توقف
Communication Protocol	: CANbus	Протокол связи	: CANbus	Haberleşme Protokolü	: CANbus	نوع التواصل	: كرت جان بوس
Encoder Options	: 5V TTL, 10-30V HTL, EnDat, SSI, SinCos, BISS	Параметры кодирования	: 5 В TTL, 10-30 В HTL, EnDat, SSI, SinCos, BISS	Enkoder Opsiyonları	: 5V TTL, 10-30V HTL, EnDat, SSI, SinCos, BISS	خيارات التشفير	: 5V TTL, 10-30V HTL, EnDat, SSI, SinCos, BISS
Safety Circuit Voltage	: 48 VAC - 250 VAC	Напряжение цепи безопасности	: 48 В переменного тока - 250 В переменного тока	Güvenlik Devresi Gerilimi	: 48 VAC - 250 VAC	جهد دائرة السلامة	: 48 VAC - 250 VAC



Specifications | Характеристики | Özellikler | المواصفات

A3 Compliant (internal door bridge control relays.)	Соответствует А3 (реле управления внутренним дверным мостом).	A3 Uyumlu (dahili kapı köprü kontrol röleleri.)	(مرحلات التحكم في جسر الباب الداخلي) A3 متوافق مع
Up to 16 stops with parallel routing	До 16 остановок при параллельной маршрутизации	Paralel tesisat ile 16 durağa kadar	ما يصل إلى 16 توقفًا مع التوجيه المتوازي
Up to 64 stops with serial bus (CANbus)	До 64 остановок с последовательной шиной (CANbus)	Seri tesisat (CANbus) ile 64 durağa kadar	ما يصل إلى 64 توقفًا مع ناقل تسلسلي (CANbus)
Double door cabin support (Automatic or semi-automatic)	Опора кабины с двойной дверью (автоматическая или полуавтоматическая)	Çift kapılı kabin desteği (Otomatik ve ya yarı otomatik)	دعم كابينة الباب المزدوج (أوتوماتيكي أو نصف أوتوماتيكي)
Leveling up, door early opening (with built-in door bridging relays)	Повышение уровня, раннее открытие двери (со встроенными реле блокировки двери)	Seviye yenileme, kapı erken açma (dahili kapı köprüleme röleleri ile)	(التسوية ، الفتح المبكر للباب (مع مرحلات توصيل مدمجة للأبواب
Full compatibility with all Arcode peripheral cards	Полная совместимость со всеми периферийными картами Arcode	Tüm Arcode çevre kartları ile tam uyumluluk	التوافق الكامل مع جميع بطاقات الطرفية Arcode
Cabinet communication: Arcode IBC + CPC cards upon request with or with the FX-CAN card	Кабинет связи: карты Arcode IBC + CPC по запросу с картой FX-CAN или с ней	Kabin haberleşme: İsteğe göre Arcode IBC + CPC kartları ile ya da FX-CAN kartı ile	اتصالات الخزانة: بطاقات عند الطلب Arcode IBC + CPC مع أو مع بطاقة FX-CAN
Well communication: optionally with ready-made installation (CANbus) or with MSP 16	Хорошая связь: опционально с готовой установкой (CANbus) или с MSP 16	Kuyu haberleşmesi: İsteğe göre hazır tesisat (CANbus) ve ya MSP 16 ile	اتصال جيد: اختياريًا مع التثبيت الجاهز 16 MSP أو مع (CANbus)

ARL700

KUMANDA PANOSU

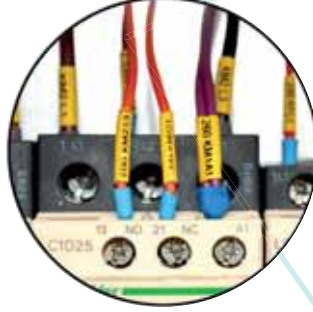

Specifications | Характеристики | Özellikler | المواصفات

Well copying: With or without motor encoder classical magnetic well system

All functions with 16x2 character LCD display access via card

All over CANbuss similar to Arcode access to functions

Serial communication with Arkel ADrive with a single cable

HSR for other motor drives and hydraulic lifts communication with the link card

Possibility of parameter copying and software update with SD card

Single socket connection with KM 25 door control card (CANbus)

Копирование лунок: обычная магнитная колодец с энкодером двигателя или без него

Все функции с ЖК-дисплеем 16x2 символов доступ через карту

Доступ ко всем функциям через CANbus аналогично Arcode

Последовательная связь с Arkel ADrive с помощью одного кабеля

HSR для других моторных приводов и гидроподъемников связь со ссылкой картой

Возможность копирования параметров и обновления ПО с SD-карты

Подключение к одной розетке с картой управления дверью KM 25 (CANbus)

Kuyu kopyalama: Motor enkoderi ile veya enkodersiz klasik mıknatıslı kuyu sistemi

16x2 karakter LCD gösterge ile tüm fonksiyonları kart üzerinden erişim

Arcode benzer CANbuss üzerinden tüm fonksiyonlara erişim imkanı

Arkel ADrive ile tek kablo ile seri iletişim

Diğer motor sürücülerini ve hidrolik asansörler için HSR bağlantı kartı ile iletişim

SD kart ile parametre kopyalama ve yazılım güncelleme imkanı

KM 25 kapı kontrol kartı ile tek sokette bağlantı (CANbus)

حسن النسخ: مع أو بدون مشفر المحرك نظام الأبار المغناطيسية الكلاسيكية

الوصول إلى جميع الوظائف عبر بطاقة مع شاشة حرف 2 × 16 LCD

الوصول إلى جميع الوظائف عبر CANbuss على غرار Arcode

اتصال تسلسلي مع Arkel ADrive بـ كابل واحد

HSR لحركات المحركات الأخرى والمساعد الهيدروليكية التواصل مع بطاقة الارتباط

إمكانية نسخ المعلمات وتحديث البرامج ببطاقة SD

اتصال مقبس واحد مع بطاقة التحكم في الباب (CANbus) KM 25

Plug and Play System

СИСТЕМА ПОДКЛЮЧИ И ИГРАЙ

Hazir Tesisat

طقم التركيب الجاهز

Control Panel and Equipment

- 1 Elevator Control Panel
- 2 Handheld Terminal
- 3 Elevator Motor
- 4 Emergency Stop Button
- 5 Speed Regulator
- 6 Revision Panel
- 7 Flexible Cable
- 8 Lighting Fixture
- 9 Floor Button
- 10 Floor Button Connection Module
- 11 Landing Door Connection Connector
- 12 Floor Sensing Sensor and Limit Circuit Breaker
- 13 Longitudinal Photocell
- 14 Cabin Lamp
- 15 Cabin Fan
- 16 Under Cabinet Bypass Siren
- 17 Roller Limit Circuit Breaker
- 18 Interior Door Command and Security Circuit
- 19 Cabin Button
- 20 Pit Panel
- 21 Intercom Phone
- 22 Regulator Rope Tensioner Contact
- 23 Cabin and Counterweight Contact
- 24 Pit Reset Switch

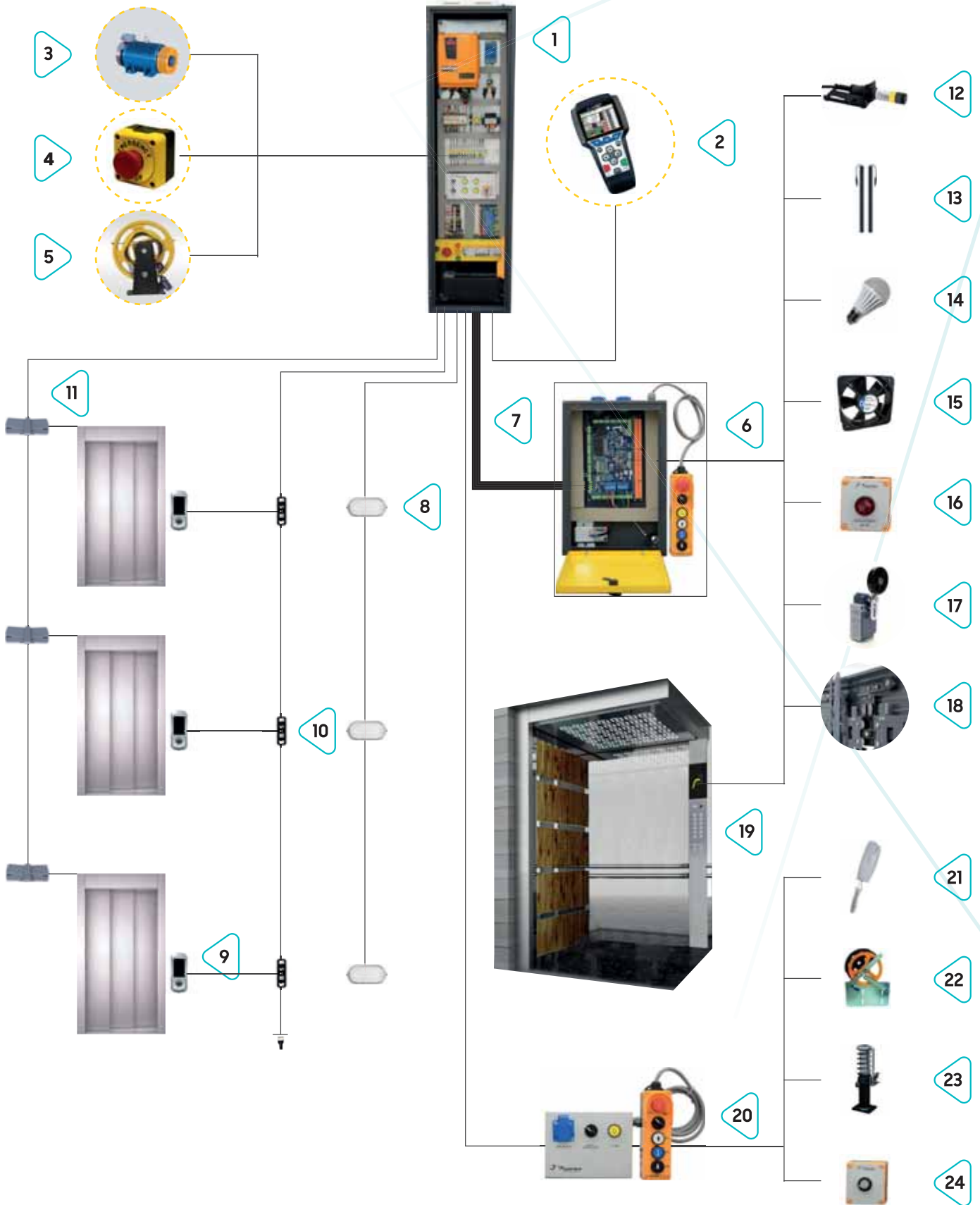



Cabin | Кабина | **Kabin** | الكبائن

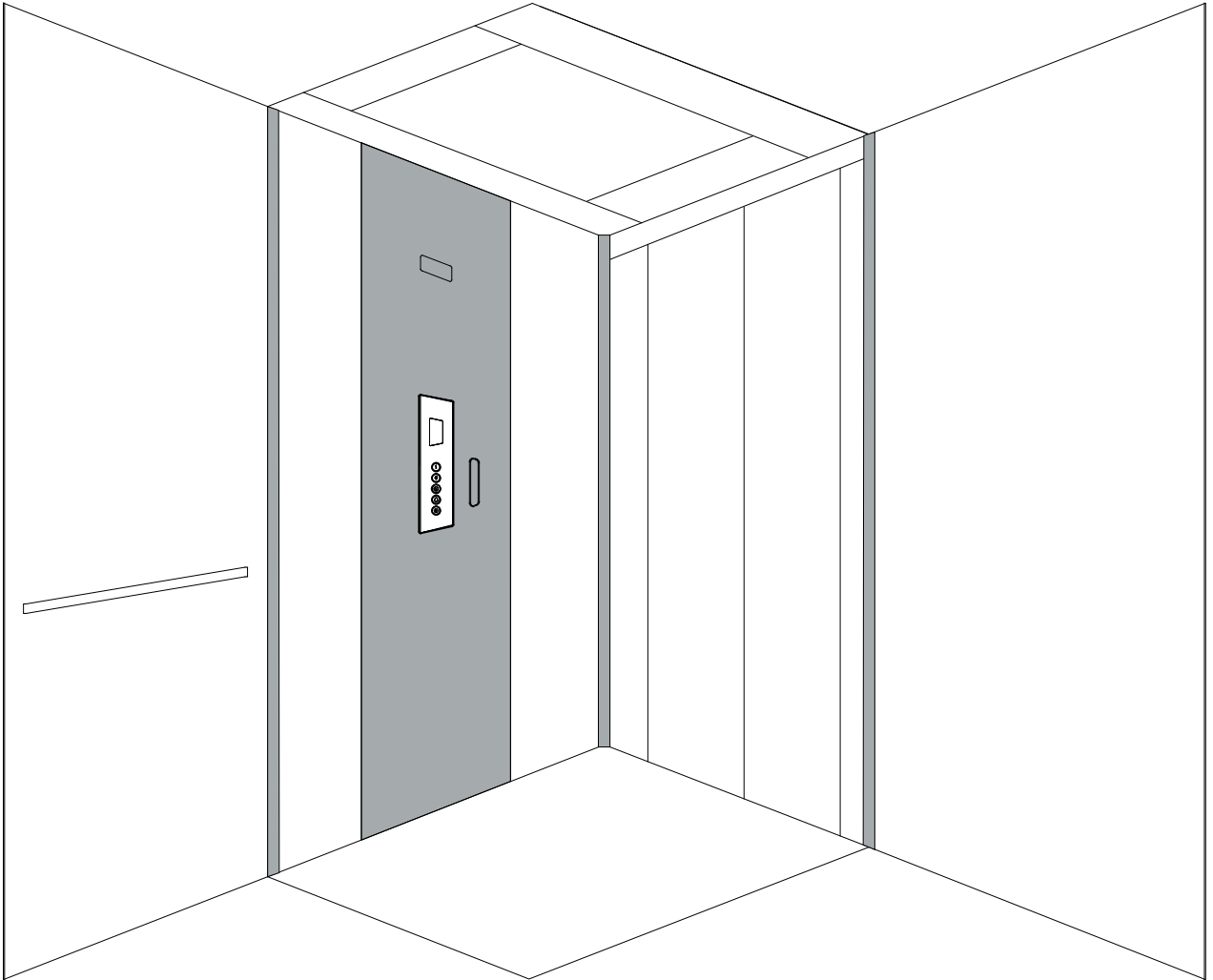

STANDART CABIN SIZE

СТАНДАРТНЫЙ РАЗМЕР КАБИНЫ

Standart Kabin Ölçüsü

حجم المقصورة القياسي

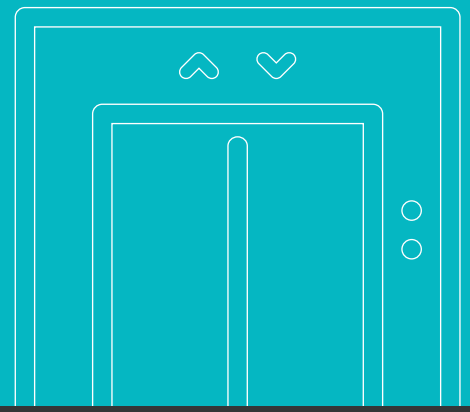

		320	400	450	600	750	975	1200	1575	1950
RATED LOAD	KG	320	400	450	600	750	975	1200	1575	1950
PASSENGER	PERSON	4	5	6	8	10	13	16	21	26
CABIN INTERNAL AREA	m ²	0.9	1.1	1.2	1.54	1.89	2.24	2.76	3.36	4.05
CABIN INTERNAL WIDTH	mm	900	1100	1000	1100	1350	1600	1200	1400	1500
CABIN INTERNAL DEPTH	mm	1000	1000	1200	1400	1400	1400	2300	2400	2700
CABIN INTERNAL HEIGHT	mm	2100	2100	2100	2100	2100	2100	2100	2100	2250
CABIN DOOR WIDTH	mm	700	800	800	800	800	1100	1100	1300	1300
CABIN DOOR HEIGHT	mm	2000	2000	2000	2000	2000	2000	2000	2000	2000





Specifications | Характеристики | Özellikler | المواصفات

LPC 1409

Side exterior wall : 1.5 mm galvanized steel sheet	Боковая внешняя стена 1,5 мм стальной оцинкованный лист	Yan Dış Duvar : 1.5 mm Galvanizli Sac	الجدار الخارجي الجانبي : صاج مغلفن 1.5 مم
Side walls : Membrane Model	Боковые стенки Мембранная модель	Yan Duvarlar : Membran Model	الجدران الجانبية : غمط زخرفي أبيض مطلي بالورنيش
Back Wall : Half - Lenght Mirror	Задняя стенка Зеркало в погроста	Arka Duvar : Yarım Boy Ayna	الجدار الخلفي : مرآة نصف طولية
Ceiling : Aser Cut Stainless Spotlight ops.	Потолок Лазерная обработка, Нержавеющий, Светильник	Tavan : Lazer Kesim Paslanmaz Spot	السقف : مصمم بالليزر
Floor : Natural Granite	Пол Натуральный гранит	Taban : Doğal Granit	أرضية : الجرانيت الطبيعي
Accessories : Satin Stainless	Аксессуары Покрывтие из нержавеющей	Aksesuarlar : Satine Paslanmaz	الإكسسوارات : مقاومة للصدأ
Handrail : Chrome - Aluminum	Поручень Хром - Алюминий	Küpeşte : Krom - Alüminyum	درايزين : كروم - ألومنيوم

THEECOSYSTEM
LPC 1410

Specifications | Характеристики | Özellikler | المواصفات

LPC 1410

Side exterior wall : 1.5 mm Galvanized Steel Sheet	Боковая внешняя стена 1,5 мм стальной оцинкованный лист	Yan Dış Duvar : 1.5 mm Galvanizli Sac	الجدار الخارجي الجانبي : صاج مغلفن 1.5 مم
Side walls : High Gloss Coating Model	Боковые стенки Высокоглянцевое покрытие	Yan Duvarlar : High Gloss model	الجدران الجانبية : نموذج شديد اللمعان
Back Wall : Half-Lenght Mirror	Задняя стенка Зеркало на уровне колен	Arka Duvar : Diz Boyu Ayna	الجدار الخلفي : مرآة طولية ونصف طولية
Ceiling : Aser Cut Stainless Spotlight ops.	Потолок Лазерная обработка, Нержавеющий, Светильник Опция	Tavan : Lazer Kesim Paslanmaz Spot Seçeneği	السقف : مصمم بالليزر
Floor : Imported Pvc	Пол Импортерный ПВХ	Taban : İthal PVC	أرضية : PVC المستورد
Accessories : Green Decorative Stainless	Аксессуары Покрyтие из нержавеющей	Aksesuarlar : Satine Paslanmaz	الإكسسوارات : مقاومة للصدأ
Handrail : Chrome - Aluminum	Поручень Хром - Алюминий	Küpeşte : Krom - Alüminyum	درابزين : كروم - ألومنيوم



LPC 1411
THE ECOSYSTEM

Specifications | Характеристики | Özellikler | المواصفات

LPC 1411

Side exterior wall : 1.5 mm Galvanized Steel Sheet	Боковая внешняя стена 1,5 мм стальной оцинкованный лист	Yan Dış Duvar : 1.5 mm Galvanizli Sac	الجدار الخارجي الجانبي : صاج مغلفن 1.5 مم
Side walls : Membrane Model	Боковые стенки Мембранная модель	Yan Duvarlar : Membran Model	الجدان الجانبية : أرضيات حجرية مزخرفة
Back Wall : Decorative Stone Cladding Full Size	Задняя стенка Декоративный каменный пол, Зеркало в рост	Arka Duvar : Dekoratif Taş Döşeme - Boy Ayna	الجدار الخلفي : الكسوة الحجرية المزخرفة - مرآة كاملة الطول
Ceiling : Laser Cut Stainless Spotlight Opt.	Потолок Лазерная обработка, Нержавеющий	Tavan : Lazer Kesim Paslanmaz	السقف : مصمم بالليزر
Floor : Natural Granite	Пол Натуральный гранит	Taban : Doğal Granit	أرضية : الجرانيت الطبيعي
Accessories : Satin Stainless	Аксессуары Покрывтие из нержавеющей	Aksesuarlar : Satine Paslanmaz	الإكسسوارات : مقاومة للصدأ
Handrail : Chrome - Aluminum	Поручень Хром - Алюминий	Küpeşte : Krom - Alüminyum	درايزين : كروم - ألومنيوم

THEECOSYSTEM
LPC1412

Specifications | Характеристики | Özellikler | المواصفات

LPC 1412

Side exterior wall : 1.5 mm Galvanized Steel Sheet	Боковая внешняя стена 1,5 мм стальной оцинкованный лист	Yan Dış Duvar : 1.5 mm Galvanizli Sac	الجدار الخارجي الجانبي : صاج مغلفن 1.5 مم
Side walls : Laminate Model	Боковые стенки Покрyтие ламинат	Yan Duvarlar : Laminant Model	الجدران الجانبية : صفائح خشبية
Back Wall : Half - Lenght Mirror	Задняя стенка Зеркало в погроста	Arka Duvar : Yarım Boy Ayna	الجدار الخلفي : نصف - طول امرأة
Ceiling : Laser Cut Stainless Spotlight Opt.	Потолок Лазерная обработка, Нержавеющий Светильник Опция	Tavan : Lazer Kesim Paslanmaz Spot Seçeneği	السقف : مصمم بالليزر
Floor : Imported Pvc	Пол Импортный ПВХ	Taban : İthal PVC	أرضية : PVC المستورد
Accessories : Satin Stainless	Аксессуары Покрyтие из нержавеющей	Aksesuarlar : Satine Paslanmaz	الإكسسوارات : مقاومة للصدأ
Handrail : Chrome - Aluminum	Поручень Хром - Алюминий	Küpeşte : Krom - Alüminyum	درابزين : كروم - ألومنيوم



LPC 1510
THE ECOSYSTEM

Specifications | Характеристики | Özellikler | المواصفات

LPC 1510

Side exterior wall : 1.5 mm galvanized steel sheet	Боковая внешняя стена 1,5 мм стальной оцинкованный лист	Yan Dış Duvar : 1.5 mm Galvanizli Sac	الجدار الخارجي الجانبي : صاج مغلفن 1.5 مم
Side walls : horizontal stainless satin	Боковые стенки Горизонтальное нержавеющей покрытие	Yan Duvarlar : Yatay Satine Paslanmaz	الجدران الجانبية : صفائح افقية مقاومة للصدأ
Back Wall : Full Size Mirror	Задняя стенка Зеркало в рост	Arka Duvar : Boya Ayna	الجدار الخلفي : مرآة كاملة الطول
Ceiling : Laser Cut Stainless/Spotlight Opt.	Потолок Лазерная обработка, Нержавеющий/Светильник Опция	Tavan : Lazer Kesim Paslanmaz-Spot Seçenek	السقف : مصمم بالليزر
Floor : Natural Granite	Пол Натуральный гранит	Taban : Doğal Granit	أرضية : الجرانيت الطبيعي
Accessories : Mirror Stainless	Аксессуары Покрyтие из нержавеющей	Aksesuarlar : Ayna Paslanmaz	الإكسسوارات : مقاومة للصدأ
Handrail : Chrome - Aluminum	Поручень Хром - Алюминий	Küpeşte : Krom - Alüminyum	درازين : الكروم-الألومنيوم

THEECOSYSTEM
LPC 1511

Specifications | Характеристики | Özellikler | المواصفات

LPC 1511

Side exterior wall : 1.5 mm galvanized steel sheet	Боковая внешняя стена 1,5 мм стальной оцинкованный лист	Yan Dış Duvar : 1.5 mm Galvanizli Sac	الجدار الخارجي الجانبي : صاج مغلفن 1.5 مم
Side walls : Vertical Stainless Satin	Боковые стенки Вертикальное нержавеющее покрытие	Yan Duvarlar : Dikey Satine Paslanmaz	الجدار الجانبية : صفائح مقاومة للصدأ عمودية
Back Wall : Full Size Mirror	Задняя стенка Зеркало в рост	Arka Duvar : Boy Ayna	الجدار الخلفي : مرآة كاملة الطول
Ceiling : Laser Cut Stainless/Spotlight Opt.	Потолок Лазерная обработка, Нержавеющий/Светильник Опция	Tavan : Lazer Kesim Paslanmaz-Spot Seçenek	السقف : مصمم بالليزر
Floor : Imported PVC	Пол Натуральный гранит	Taban : İthal PVC	أرضية : PVC مستورد
Accessories : Mirror Stainless	Аксессуары Покрyтие из нержавеющей	Aksesuarlar : Ayna Paslanmaz	الإكسسوارات : مقاومة للصدأ
Handrail : Chrome - Aluminum	Поручень Хром - Алюминий	Küpeşte : Krom - Alüminyum	درازين : الكروم-الألومنيوم



Specifications | Характеристики | Özellikler | المواصفات

LPC 1512

Side exterior wall : 1.5 mm galvanized steel sheet	Боковая внешняя стена 1,5 мм стальной оцинкованный лист	Yan Dış Duvar : 1.5 mm Galvanizli Sac	الجدار الخارجي الجانبي : صاج مغلفن 1.5 مم
Side walls : 304 Golden Steel	Боковые стенки Золотая Нержавеющая Сталь 304	Yan Duvarlar : 304 Sarı Ayna Paslanmaz	الجدران الجانبية : من الفولاذ الأذهبي 304
Back Wall : Half - Length Mirror	Задняя стенка Зеркало в полроста	Arka Duvar : Yarım Boy Ayna	الجدار الخلفي : مرآة كاملة الطول
Ceiling : Laser Ceiling Option	Потолок Лазерная обработка, Опция	Tavan : Lazer Tavan Seçenekleri	السقف : مصمم بالليزر
Floor : Various Floor Furnishings Options	Пол Различные варианты отделки пола	Taban : Zengin Taban Döşeme Seçenekleri	أرضية : خيارات أثاث الأرضيات المختلفة
Accessories : Golden Stainless Accessory	Аксесуары Из золотой нержавеющей	Aksesuarlar : Sarı Paslanmaz Aksesuar	الإكسسوارات : مقاومة للصدأ
Handrail : Chrome - Aluminum	Поручень Хром - Алюминий	Küpeşte : Krom - Alüminyum	درايزين : الكروم-الألومنيوم

THEECOSYSTEM
LPC 1513

Specifications | Характеристики | Özellikler | المواصفات

LPC 1513

Side exterior wall : 1.5 mm galvanized steel sheet	Боковая внешняя стена 1,5 мм стальной оцинкованный лист	Yan Dış Duvar : 1.5 mm Galvanizli Sac	الجدار الخارجي الجانبي : صاج مغلفن 1.5 مم
Side walls : Copper Model	Боковые стенки Модель с Медным узором	Yan Duvarlar : Bakır Desenli Model	الجدران الجانبية : نموذج النحاس
Back Wall : Half - Lenght Mirror	Задняя стенка Зеркало в погроста	Arka Duvar : Yarım Boy Ayna	الجدار الخلفي : نصف - طول امرأة
Ceiling : Laser Ceiling Option	Потолок Вариант лазерного потолка	Tavan : Lazer Tavan Seçenekleri	السقف : مصمم بالليزر
Floor : Various Floor Furnishings Options	Пол Различные варианты отделки пола	Taban : Zengin Taban Döşeme Seçenekleri	أرضية : خيارات متنوعة لمفروشات الأرضيات
Accessories : Copper Stainless Accessory	Аксессуары Медное зеркало нержавеющей аксессуар	Aksesuarlar : Bakır Ayna Paslanmaz Aksesuar	الإكسسوارات : اكسسوار نحاسي غير قابل للصدأ
Handrail : Chrome - Aluminum	Поручень Хром - Алюминий	Küpeşte : Krom - Alüminyum	درازين : الكروم-الألومنيوم



Specifications | Характеристики | Özellikler | المواصفات

LPC 1514

Side exterior wall : 1.5 mm galvanized steel sheet	Боковая внешняя стена 1,5 мм стальной оцинкованный лист	Yan Dış Duvar : 1.5 mm Galvanizli Sac	الجدار الخارجي الجانبي : صاج مغلفن 1.5 مم
Side walls : Decorative Steel	Боковые стенки Декоративная нержавейка	Yan Duvarlar : Dekoratif Paslanmaz	الجدران الجانبية : ديكور ستيل
Back Wall : Full Size Mirror	Задняя стенка Зеркало в рост	Arka Duvar : Boy Ayna	الجدار الخلفي : مرآة كاملة الطول
Ceiling : Laser Ceiling Option	Потолок Варианты с Лазерной обработкой	Tavan : Lazer Tavan Seçenekleri	السقف : مصمم بالليزر
Floor : Various Floor Furnishings Options	Пол Различные варианты отделки пола	Taban : Zengin Taban Döşeme Seçenekleri	أرضية : خيارات متنوعة لمفروشات الأرضيات
Accessories : Stainless Accessory	Аксессуары Из нержавеющей стали	Aksesuarlar : Paslanmaz Aksesuar	الإكسسوارات : مقاومة للصدأ
Handrail : Chrome - Aluminum	Поручень Хром - Алюминий	Küpeşte : Krom - Alüminyum	درايزين : الكروم-الألومنيوم

THEECOSYSTEM
LPC 1515

Specifications | Характеристики | Özellikler | المواصفات

LPC 1515

Side exterior wall : 1.5 mm galvanized steel sheet	Боковая внешняя стена 1,5 мм стальной оцинкованный лист	Yan Dış Duvar : 1.5 mm Galvanizli Sac	الجدار الخارجي الجانبي : صاج مغلفن 1.5 مم
Side walls : 304 Stainless Steel	Боковые стенки 304 нержавеющей сталь	Yan Duvarlar : 304 Paslanmaz	الجدران الجانبية : من الفولاذ المقاوم للصدأ 304
Back Wall : Full Size Mirror	Задняя стенка Зеркало в рост	Arka Duvar : Boy Ayna	الجدار الخلفي : مرآة كاملة الطول
Ceiling : Laser Ceiling Option	Потолок Варианты лазерного потолка	Tavan : Lazer Tavan Seçenekleri	السقف : مصمم بالليزر
Floor : Various Floor Furnishings Options	Пол Различные варианты отделки пола	Taban : Zengin Taban Döşeme Seçenekleri	أرضية : خيارات متنوعة لمفروشات الأرضيات
Accessories : Stainless Accessory	Аксессуары Из нержавеющей стали	Aksesuarlar : Paslanmaz Aksesuar	الإكسسوارات : مقاومة للصدأ
Handrail : Chrome - Aluminum	Поручень Хром - Алюминий	Küpeşte : Krom - Alüminyum	درايزين : الكروم-الألومنيوم

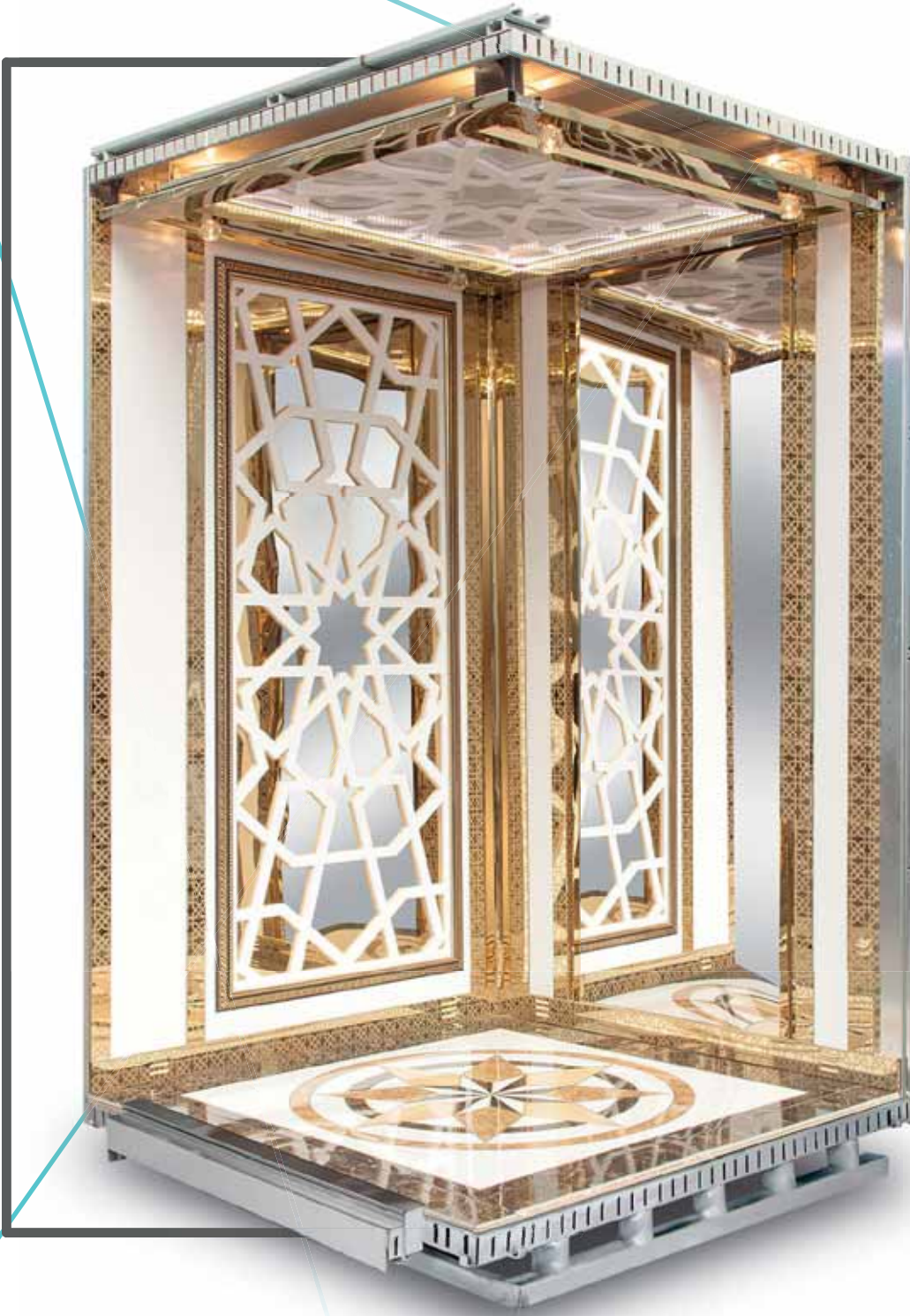

Specifications | Характеристики | Özellikler | المواصفات

LPC 1516

Side exterior wall : 1.5 mm galvanized steel sheet	Боковая внешняя стена 1,5 мм стальной оцинкованный лист	Yan Dış Duvar : 1.5 mm Galvanizli Sac	الجدار الخارجي الجانبي : صاج مغلفن 1.5 مم
Side walls : Special Designed Wooden Model	Боковые стенки Специально разработанная деревянная модель	Yan Duvarlar : Özel Tasarım Dyma Seçenekleri	الجدران الجانبية : نموذج خشبي خاص التصميم
Back Wall : Full Size Mirror	Задняя стенка Зеркало в рост	Arka Duvar : Boy Ayna	الجدار الخلفي : مرآة كاملة الطول
Ceiling : Laser Ceiling Option	Потолок Вариант лазерного потолка	Tavan : Lazer Tavan Seçenekleri	السقف : مصمم بالليزر
Floor : Various Floor Furnishings Options	Пол Различные варианты отделки пола	Taban : Zengin Taban Döşeme Seçenekleri	أرضية : خيارات متنوعة لمفروشات الأرضيات
Accessories : Various Stainless Steel Options	Аксессуары Различных варианты из нержавеющей стали	Aksesuarlar : Zengin Paslanmaz Seçenekleri	الإكسسوارات : مقاومة للصدأ
Handrail : Chrome - Aluminum	Поручень Хром - Алюминий	Küpeşte : Krom - Alüminyum	درايزين : الكروم-الألومنيوم

THEECOSYSTEM
LPC 1517

Specifications | Характеристики | Özellikler | المواصفات

LPC 1517

Side exterior wall : 1.5 mm galvanized steel sheet	Боковая внешняя стена 1,5 мм стальной оцинкованный лист	Yan Dış Duvar : 1.5 mm Galvanizli Sac	الجدار الخارجي الجانبي : صاج مغلفن 1.5 مم
Side walls : Various Design Stone Model	Боковые стенки Различные варианты каменной отделки	Yan Duvarlar : Zengin Taş Seçenekleri	الجدران الجانبية : موديل حجري بتصاميم مختلفة
Back Wall : Full Size Mirror	Задняя стенка Зеркало в рост	Arka Duvar : Boy Ayna	الجدار الخلفي : مرآة كاملة الطول
Ceiling : Laser Ceiling Option	Потолок Различные варианты лазерной обработки	Tavan : Lazer Tavan Seçenekleri	السقف : مصمم بالليزر
Floor : Various Floor Furnishings Options	Пол Различные варианты отделки пола	Taban : Zengin Taban Döşeme Seçenekleri	أرضية : خيارات متنوعة لمفروشات الأرضيات
Accessories : Various Stainless Steel Options	Аксессуары Различных варианты из нержавеющей стали	Aksesuarlar : Zengin Paslanmaz Seçenekleri	الإكسسوارات : مقاومة للصدأ
Handrail : Chrome - Aluminum	Поручень Хром - Алюминий	Küpeşte : Krom - Alüminyum	درايزين : الكروم-الألومنيوم



Specifications | Характеристики | Özellikler | المواصفات

LPC 1518

Side exterior wall : 1.5 mm galvanized steel sheet	Боковая внешняя стена 1,5 мм стальной оцинкованный лист	Yan Dış Duvar : 1.5 mm Galvanizli Sac	الجدار الخارجي الجانبي : صاج مغلفن 1.5 مم
Side walls : Industrial Leather and Brown Double	Боковые стенки Промышленная кожа и двойное зеркало, нержавейка	Yan Duvarlar : Sinali Deri ve Double Ayna Paslanmaz	الجدران الجانبية : جلد صناعي وبني مزدوج
Back Wall : Full Size Mirror	Задняя стенка Зеркало в рост	Arka Duvar : Boy Ayna	الجدار الخلفي : مرآة كاملة الطول
Ceiling : Laser Ceiling Option	Потолок Различные варианты лазерной обработки	Tavan : Lazer Tavan Seçenekleri	السقف : مصمم بالليزر
Floor : Various Floor Furnishings Options	Пол Различные варианты отделки пола	Taban : Zengin Taban Döşeme Seçenekleri	أرضية : خيارات متنوعة لمفروشات الأرضيات
Accessories : Various Stainless Steel Options	Аксессуары Различные варианты из нержавеющей стали	Aksesuarlar : Zengin Paslanmaz Seçenekleri	الإكسسوارات : مقاومة للصدأ
Handrail : Chrome - Aluminum	Поручень Хром - Алюминий	Küpeşte : Krom - Alüminyum	درايزين : الكروم-الألومنيوم

THEECOSYSTEM
LPC 1609

Specifications | Характеристики | Özellikler | المواصفات

LPC 1609

Side exterior wall	: 1.5 mm galvanized steel sheet	Боковая внешняя стена	: 1,5 мм стальной оцинкованный лист	Yan Dış Duvar	: 1.5 mm Galvanizli Sac	الجدار الخارجي الجانبي	: صاج مغلفن 1.5 مم
Side walls	: 6 mm Monoblock Laminated Glass	Боковые стенки	: 6 мм Моноблок ламинированное стекло с цифровой печатью	Yan Duvarlar	: 6mm Monoblok Lamine Cam D.Baskı	الجدران الجانبية	: الواجه الزجاجية طباعة رقمية
Back Wall	: Full Size Mirror	Задняя стенка	: Зеркало в рост	Arka Duvar	: Boy Ayna	الجدار الخلفي	: مرآة كاملة الطول
Ceiling	: 6 mm Laminated Glass Digital Print	Потолок	: 6 мм Ламинированное стекло - Цифровая печать	Tavan	: 6 mm Lamine Cam - Dijital Baskı	السقف	: 6 مم لوح زجاجي - طباعة رقمية
Floor	: 8 mm laminated - tempered	Пол	: 8 мм Ламинированный - Темперированный- Цифровая печать	Taban	: 8 mm Lamine - Temperli - Dijital baskı	أرضية	: صفايح طباعة رقمية
Accessories	: Satin Stainless	Аксессуары	: Покрытие из нержавеющей	Aksesuarlar	: Satine Paslanmaz	الإكسسوارات	: مقاومة للصدأ
Handrail	: Chrome - Aluminum	Поручень	: Хром - Алюминий	Küpeste	: Krom - Alüminyum	درايزين	: الكروم-الألومنيوم



Specifications | Характеристики | Özellikler | المواصفات

LPC 1610

Side exterior wall : 1.5 mm galvanized steel sheet	Боковая внешняя стена 1,5 мм стальной оцинкованный лист	Yan Dış Duvar : 1.5 mm Galvanizli Sac	الجدار الخارجي الجاني : صاج مغلفن 1.5 مم
Side walls : 6 mm Monoblock Laminated Glass	Боковые стенки 6 мм Моноблок ламинированное стекло с цифровой печатью	Yan Duvarlar : 6mm Monoblok Lamine Cam D.Baski	الجدران الجانبية : الواجه زجاجية طباعة رقمية
Back Wall : Full Size Mirror	Задняя стенка Зеркало в рост	Arka Duvar : Boy Ayna	الجدار الخلفي : مرآة كاملة الطول
Ceiling : 6 mm Laminated Glass Digital Print	Потолок 6 мм Ламинированное стекло - Цифровая печать	Tavan : 6 mm Lamine Cam – Dijital Baski	السقف : 6 مم لوح زجاجي - طباعة رقمية
Floor : 8 mm laminated - tempered	Пол 8 мм Ламинированный - Темперированный- Цифровая печать	Taban : 8 mm Lamine – Tempertli – Dijital baski	أرضية : صفائح طباعة رقمية
Accessories : Satin Stainless	Аксессуары Покрyтие из нержавеющей	Aksesuarlar : Satine Paslanmaz	الإكسسوارات : مقاومة للصدأ
Handrail : Chrome - Aluminum	Поручень Хром - Алюминий	Küpeşte : Krom - Alüminyum	درايزين : الكروم-الألومنيوم

THEECOSYSTEM
LPC 1611

Specifications | Характеристики | Özellikler | المواصفات

LPC 1611

Side exterior wall	: 1.5 mm galvanized steel sheet	Боковая внешняя стена	: 1,5 мм стальной оцинкованный лист	Yan Dış Duvar	: 1.5 mm Galvanizli Sac	الجدار الخارجي الجانبي	: صاج مغلفن 1.5 مم
Side walls	: 6 mm Monoblock Laminated Glass	Боковые стенки	: 6 мм Моноблок ламинированное стекло с цифровой печатью	Yan Duvarlar	: 6mm Monoblok Lamine Cam D.Baskı	الجدران الجانبية	: الواجهات الزجاجية طباعة رقمية
Back Wall	: Full Size Mirror	Задняя стенка	: Зеркало в рост	Arka Duvar	: Boy Ayna	الجدار الخلفي	: مرآة كاملة الطول
Ceiling	: 6 mm Laminated Glass Digital Print	Потолок	: 6 мм Ламинированное стекло - Цифровая печать	Tavan	: 6 mm Lamine Cam - Dijital Baskı	السقف	: مم لوح زجاجي - طباعة رقمية
Floor	: 8 mm laminated - tempered	Пол	: 8 мм Ламинированный - Темперированный- Цифровая печать	Taban	: 8 mm Lamine - Temperli - Dijital baskı	أرضية	: مصفحات طباعة رقمية
Accessories	: Satin Stainless	Аксессуары	: Покрытие из нержавеющей стали	Aksesuarlar	: Satine Paslanmaz	الإكسسوارات	: مقاومة للصدأ
Handrail	: Chrome - Aluminum	Поручень	: Хром - Алюминий	Küpeşte	: Krom - Alüminyum	درايزين	: الكروم-الألومنيوم

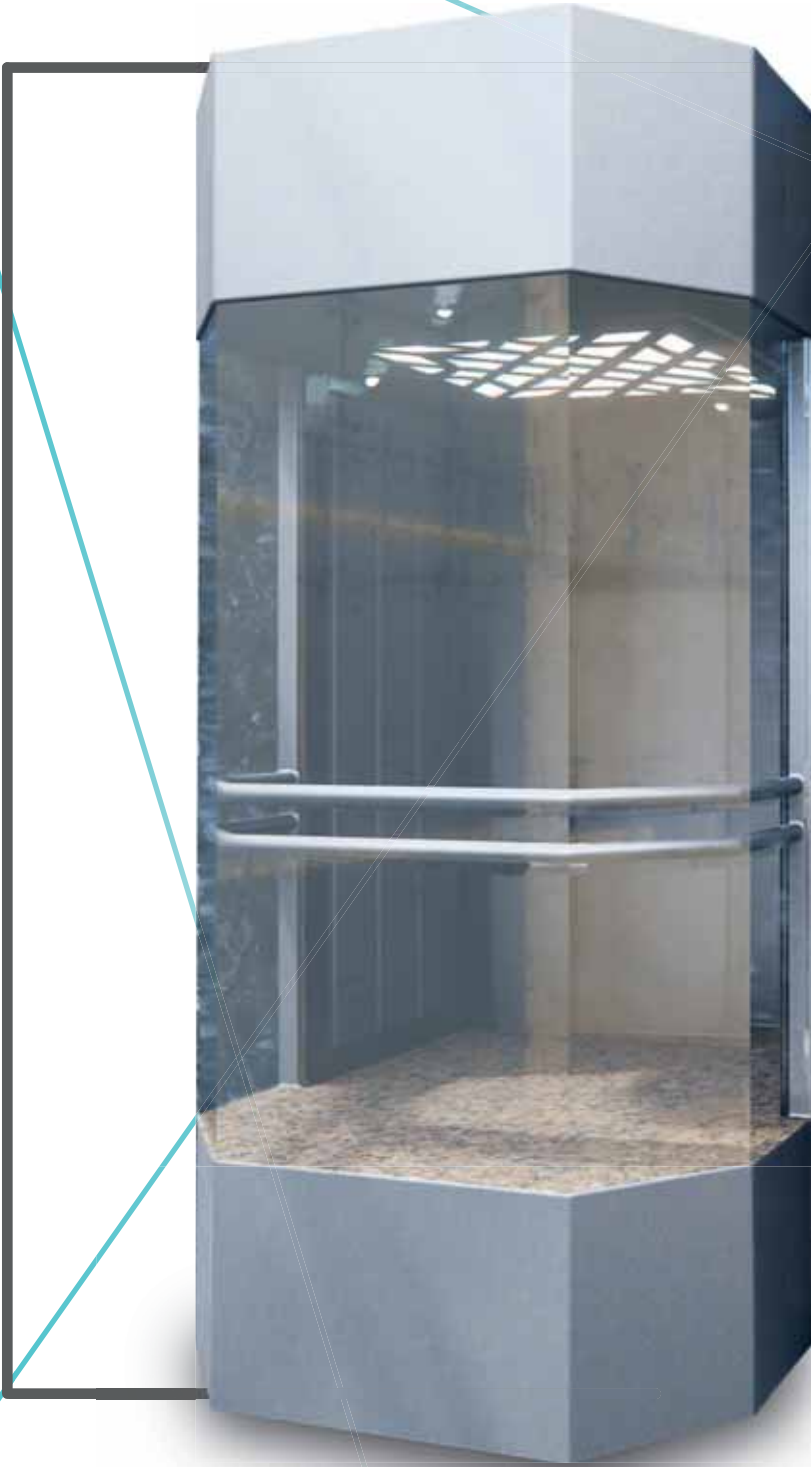

Specifications | Характеристики | Özellikler | المواصفات

LPC 1708

Side exterior wall : 1.5 mm galvanized steel sheet	Боковая внешняя стена 1,5 мм стальной оцинкованный лист	Yan Dış Duvar : 1.5 mm Galvanizli Sac	الجدار الخارجي الجانبي : صاج مغلفن 1.5 مم
Side walls : Satin Stainless	Боковые стенки Покрyтие из нержавеющей	Yan Duvarlar : Satine Paslanmaz	الجدران الجانبية : صفائح معدنية مقاومة للصدأ
Back Wall : 5/5 Cornered Laminated Glass	Задняя стенка Угльное ламинат покрытие 5/5	Arka Duvar : 5 x 5 Köşeli Lamine Cam	الجدار الخلفي : 5x5ملم زجاج قائمة الزوية
Ceiling : Laser Cut Stainless	Потолок Лазерная обработка, Нержавеющий	Tavan : Lazer Kesim Paslanmaz	السقف : صفائح معدنية مقاومة للصدأ
Floor : Natural granite	Пол Натуральный гранит	Taban : Doğal Granit	أرضية : الجرانيت الطبيعي
Accessories : Satin Stainless	Аксессуары Покрyтие из нержавеющей	Aksesuarlar : Satine Paslanmaz	الإكسسوارات : مقاومة للصدأ
Handrail : Chrome - Aluminum	Поручень Хром - Алюминий	Küpeşte : Krom - Alüminyum	درايزين : الكروم-الألومنيوم

THEECOSYSTEM
LPC1709

Specifications | Характеристики | Özellikler | المواصفات

LPC 1709

Side exterior wall	: 1.5 mm galvanized steel sheet	Боковая внешняя стена	: 1.5 mm Оцинкованный лист	Yan Dış Duvar	: 1.5 mm Galvanizli Sac	الجدار الخارجي الجانبي	: صاج مغلفن 1.5 مم
Side walls	: 5/5 Cornered Laminated Glass	Боковые стенки	: Угловое ламинат покрытие 5/5	Yan Duvarlar	: 5 x 5 Köşeli Lamine Cam	الجدران الجانبية	: 5x5ملم زجاج قائمة الزواية
Back Wall	: 5/5 Cornered Laminated Glass	Задняя стенка	: Угловое ламинат покрытие 5/5	Arka Duvar	: 5 x 5 Köşeli Lamine Cam	الجدار الخلفي	: 5x5ملم زجاج قائمة الزواية
Ceiling	: Laser Cut Stainless	Потолок	: Лазерная обработка, Нержавеющий	Tavan	: Lazer Kesim Paslanmaz	السقف	: مصمم بالليزر
Floor	: Imported Pvc	Пол	: Импортный ПВХ	Taban	: İthal PVC	أرضية	: PVC تورد
Accessories	: Satin Stainless	Аксессуары	: Покрытие из нержавеющей	Aksesuarlar	: Satine Paslanmaz	الإكسسوارات	: مقاومة للصدأ
Handrail	: Chrome - Aluminum	Поручень	: Хром - Алюминий	Küpeste	: Krom - Alüminyum	درايزين	: الكروم-الألومنيوم



Specifications | Характеристики | Özellikler | المواصفات

LPC 1710

Side exterior wall : 1.5 mm galvanized steel sheet	Боковая внешняя стена 1,5 мм стальной оцинкованный лист	Yan Dış Duvar : 1.5 mm Galvanizli Sac	الجدار الخارجي الجانبي : صاج مغلفن 1.5 مم
Side walls : Satin Stainless	Боковые стенки 6 мм Моноблок ламинированное стекло с цифровой печатью	Yan Duvarlar : Satine Paslanmaz	الجدران الجانبية : صفائح مقاومة للصدأ
Back Wall : 5/5 Radius Form Glass	Задняя стенка Радиусное ламинат покрытие 5/5	Arka Duvar : 5 x 5 Radüslü Lamine Cam	الجدار الخلفي : 5x5 زجاج مغلف
Ceiling : Laser Cut Stainless	Потолок 6 мм Ламинированное стекло - Цифровая печать	Tavan : Lazer Kesim Paslanmaz	السقف : مصمم بالليزر
Floor : Natural granite	Пол 8 мм Ламинированный - Темперированный- Цифровая печать	Taban : Doğal Granit	أرضية : الجرانيت الطبيعي
Accessories : Satin Stainless	Аксессуары Покрyтие из нержавеющей	Aksesuarlar : Satine Paslanmaz	الإكسسوارات : مقاومة للصدأ
Handrail : Chrome - Aluminum	Поручень Хром - Алюминий	Küpeşte : Krom - Alüminyum	درازين : الكروم-الألومنيوم

THEECOSYSTEM LPC 1711

Cabin | кабина | Kabin | الكبائن



Specifications | Характеристики | Özellikler | المواصفات

LPC 1711

Side exterior wall : 1.5 mm galvanized steel sheet	Боковая внешняя стена 1,5 мм стальной оцинкованный лист	Yan Dış Duvar : 1.5 mm Galvanizli Sac	الجدار الخارجي الجاني : صاج مغلفن 1.5 مم
Side walls : Satin Stainless	Боковые стенки Покрyтие из нержавеющей	Yan Duvarlar : Satine Paslanmaz	الجدران الجانبية : صفائح معدنية مقاومة للصدأ
Back Wall : 5/5 Form Glass	Задняя стенка Ламинат покрытие 5/5	Arka Duvar : 5 x 5 Lamine Cam	الجدار الخلفي : 5x5 مغلف
Ceiling : Laser Cut Stainless	Потолок Лазерная обработка, Нержавеющий	Tavan : Lazer Kesim Paslanmaz	السقف : مصمم بالليزر
Floor : Natural granite	Пол Натуральный гранит	Taban : Doğal Granit	أرضية : الجرانيت الطبيعي
Accessories : Satin Stainless	Аксессуары Покрyтие из нержавеющей	Aksesuarlar : Satine Paslanmaz	الإكسسوارات : مقاومة للصدأ
Handrail : Chrome - Aluminum	Поручень Хром - Алюминий	Küpeşte : Krom - Alüminyum	درازين : الكروم-الألومنيوم



Specifications | Характеристики | Özellikler | المواصفات

Service Elevator кухонный лифт Servis Asansörü مصعد الخدمة			LPC 1708
Capacity : 25 kg – 300 kg	Емкость 25 кг - 300 кг	Kapasite : 25 kg – 300 kg	الاستطاعة : 25 كجم - 300 كجم
Speed Weight : 0.17 - 0.60 m/second	Скорость Вес 0,17 - 0,60 м / сек	Hız Ağırlığı : 0.17 - 0.60 m / saniye	السرعة : 0.17 - 0.60 م / ثانية
Material : 1.5 mm Galvanized Sheet	Материал Оцинкованный лист 1.5 мм	Malzeme : 1.5 mm Galvanizli Sac	مادة : صاج مجلفن 1.5 مم
Operating voltage : 220 / 380 / V / AC	Рабочее напряжение 220/380 / В / AC	Çalışma Voltajı : 220 / 380 / V / AC	جهد التشغيل : فولت / تيار متردد / 220/380
Load Alarm : There is	Сигнал нагрузки Там есть	Yük Alarmı : Var	إنذار الحمل : موجود
Number of Stops : 12	Количество остановок 12	Durak Sayısı : 12	عدد المحطات : 12

THEECOSYSTEM
LPC1713

Specifications | Характеристики | Özellikler | المواصفات

LPC 1713

Side exterior wall : 1.5 mm galvanized steel sheet	Боковая внешняя стена 1.5 mm Оцинкованный лист	Yan Dış Duvar : 1.5 mm Galvanizli Sac	الجدار الخارجي الجانبي : صاج مغلفن 1.5 مم
Side walls : Satin Stainless	Боковые стенки Покрyтие из нержавеющей	Yan Duvarlar : Satine Paslanmaz	الجدران الجانبية : ستايليس غير قابل للصدأ
Ceiling : Laser Cut Stainless	Потолок Лазерная обработка, Нержавеющий/Светильник Опция	Tavan : Lazer Kesim Paslanmaz-Spot Seçenek	السقف : مصمم بالليزر
Floor : Aluminum	Пол Рифленый алюминиевый лист	Taban : Aliminyum Çeta	أرضية : سياك الألومنيوم
Accessories : Satin Stainless - Laminated Band	Аксессуары Покрyтие из нержавеющей - Ламинированный пояс	Aksesuarlar : Satine Paslanmaz - Laminant K. Bandı	الإكسسوارات : مقاومة للصدأ
Handrail : Chrome - Aluminum	Поручень Хром - Алюминий	Küpeşte : Krom - Alüminyum	درابزي : كروم - ألومنيوم



HORIZONTAL TYPE DISABLED PLATFORM

ГОРИЗОНТАЛЬНАЯ ПЛАТФОРМА ДЛЯ ИНВАЛИДОВ

Yatay Tip Engelli Asansörü

منصة افقية لمصعد المعاقين

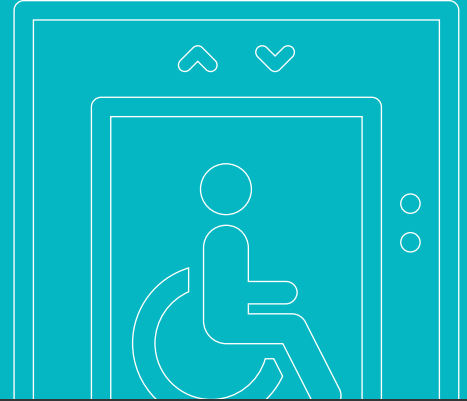

Specifications | Характеристики | Özellikler | المواصفات

- ↳ Indoor and Outdoor Suitability
- ↳ Speed : 0,1 m/s
- ↳ Standard 225 Kg. - Carrying Capacity up to 300 Kg
- ↳ Remote Control (Standard)
- ↳ Automatic Safety Stop
- ↳ Emergency Button

- ↳ İç ve Dış Mekana Uygunluk
- ↳ Hız : 0,1 m/sn
- ↳ Standart 225 Kg. - 300 Kg'a kadar Taşıma Kapasitesi
- ↳ Uzaktan Kumanda İle Çağırma (Standart)
- ↳ Otomatik Güvenlik Duruşu
- ↳ Acil Durum Düğmesi

- ↳ Подходит для внутреннего и наружного использования
- ↳ Скорость: 0,1 м / с
- ↳ Стандартный 225 кг. - Грузоподъемность до 300 кг.
- ↳ Пульт дистанционного управления (стандарт)
- ↳ Автоматическая остановка безопасности
- ↳ Тревожная кнопка

- ↳ ملاءمة داخلية وخارجية
- ↳ السرعة: 0.1 م / ث
- ↳ قياسي 225 كجم. - قدرة حمل تصل إلى 300 كجم
- ↳ جهاز التحكم عن بعد قياسي
- ↳ توقف أمان تلقائي
- ↳ زر الطوارئ

DISABLED PLATFORM

ПЛАТФОРМА ДЛЯ ИНВАЛИДОВ

Engelli Platformu

منصة مصعد منزلي للمعاقين

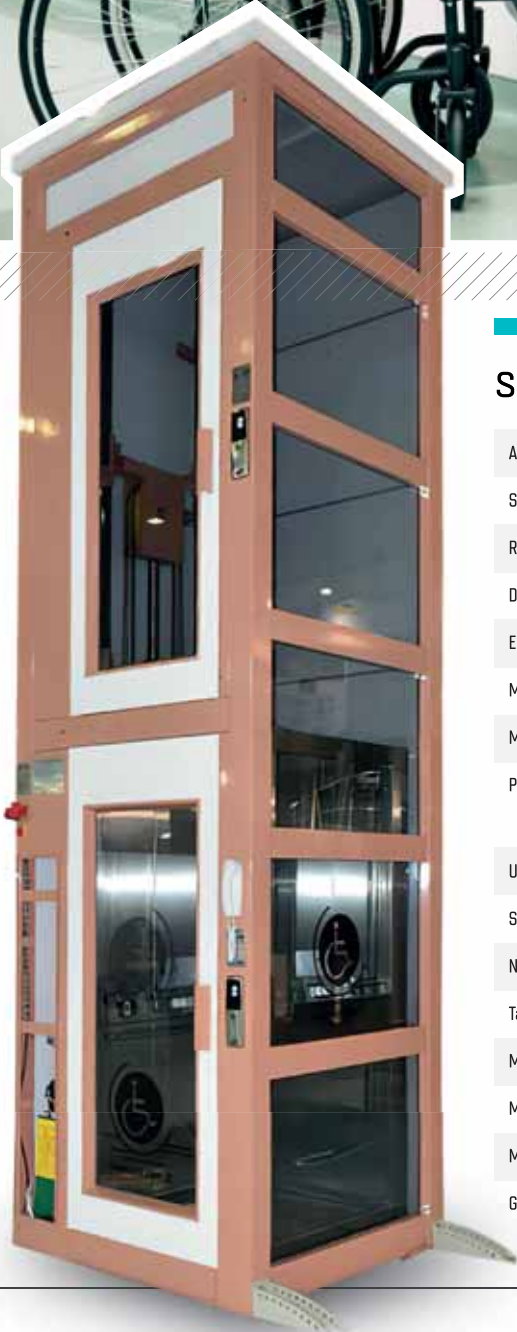

Specifications | Характеристики | Özellikler | المواصفات

Apps	: Commercial, Residential, Indoor	Программы	Коммерческий, Жилой, Крытый
Standard Capacity	: 750 lb (340 kg), 1000 lb (454 kg)	Стандартная емкость	750 фунтов (340 кг), 1000 фунтов (454 кг)
Rated Speed	: 30 ft/min (0.15 m/s)	Номинальная скорость	30 футов / мин (0,15 м / с)
Drive	: 1.2 cable hydraulic drive	Водить машину	1.2 тросовый гидравлический привод
Engine	: 3 hp submerged	Двигатель	3 л.с. под водой
Minimum Pit	: 8" (203mm)	Минимальная яма	8 дюймов (203 мм)
Minimum Headroom	: 92" (2337 mm)	Минимальный запас по высоте	92 дюйма (2337 мм)
Power Source	: 200 volts, three phase, 60 Hz, 30 amps	Источник питания	200 вольт, трехфазный, 60 Гц, 30 ампер
Uygulamalar	: Ticari, konut, iç mekan	Тطبيقات	: تجاري, سكني, داخلي
Standart kapasite	: 750 lb (340 kg), 1000 lb (454 kg)	القدرة القياسية	: رطلاً 340 كجم, 1000 رطل 454 كجم 750
Nominal hız	: 30 ft/dak (0.15 m/s)	تصنيف سريع	: قدم / دقيقة 0.15 م / ث 30
Tahrik	: 1.2 Kablolü Hidrolik Tahrik	قيادة	: محرك الكابيل الهيدروليكي 1.2
Motor	: 3HP Daldırılmış	محرك	: مغمر 3HP
Minimum Çukur	: 8" (203mm)	الحد الأدنى	: بوصات 203 ملم 8
Minimum Üst Boşluk	: 92" (2337 mm)	الحد الأدنى من الارتفاع	: بوصة 2337 ملم 92
Güç Kaynağı	: 200 Volt, Üç Fazlı, 60Hz 30 Amper	مصدر الطاقة	: فولت, ثلاثي الأطوار, 60 هرتز 30 أمبير 200



ESCALATORS AND WALKWAYS

ЭСКАЛАТОР И ПРОХОДКИ

Yürüyen Merdivenler

السلام والممرات

The elegant design of our indoor and outdoor escalators provide an aesthetic touch for major projects like shopping malls, hotels, stores, banks and office buildings.

Элегантный дизайн наших внутренних и наружных эскалаторов придает эстетичный вид крупным проектам, таким как торговые центры, отели, магазины, банки и офисные здания.

يوفر التصميم الأنيق لسلامتنا الكهربائية الداخلية والخارجية لمسحة جمالية للمشاريع الكبرى مثل مراكز التسوق والفنادق والمتاجر والبنوك ومباني المكاتب

İç ve dış mekan kullanımına özel iki ayrı kategoride üretilen yürüyen merdivenlerimiz; alışveriş merkezleri, oteller, mağazalar, bankalar, ofis binaları gibi birçok farklı projeye, modern tasarımları ile estetik değer kazandırıyorlar.





Doors | Двери | Kapılar | الابواب

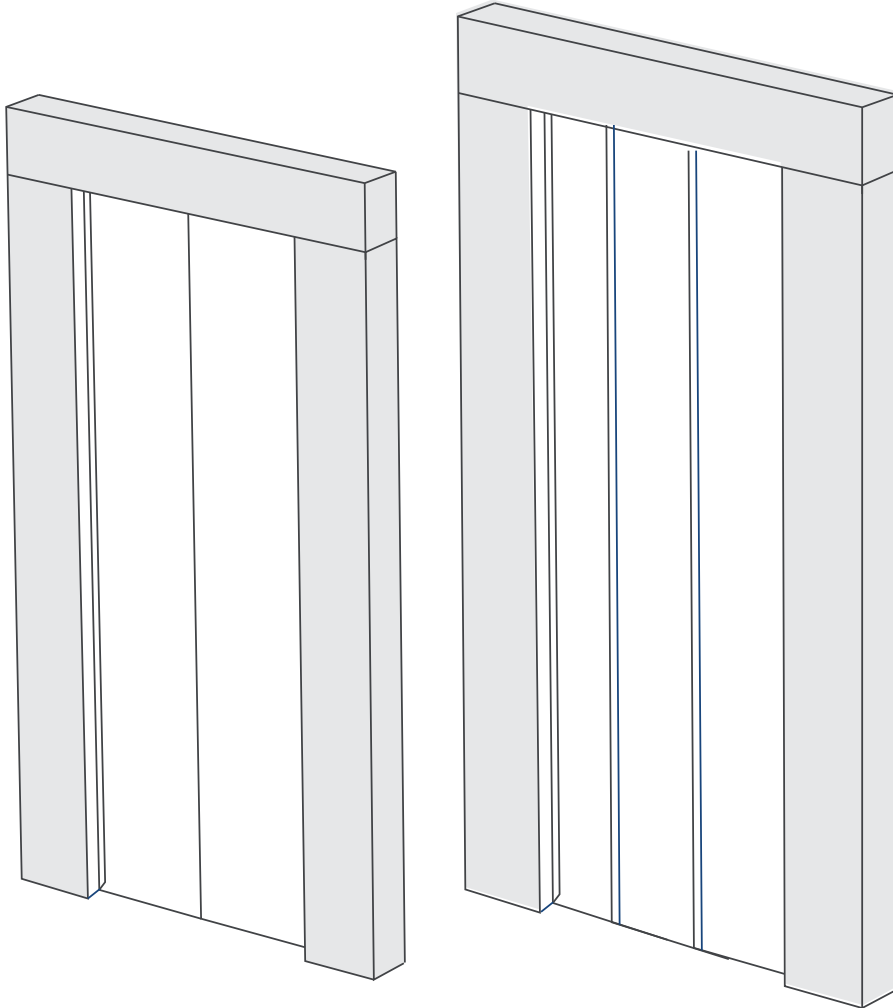

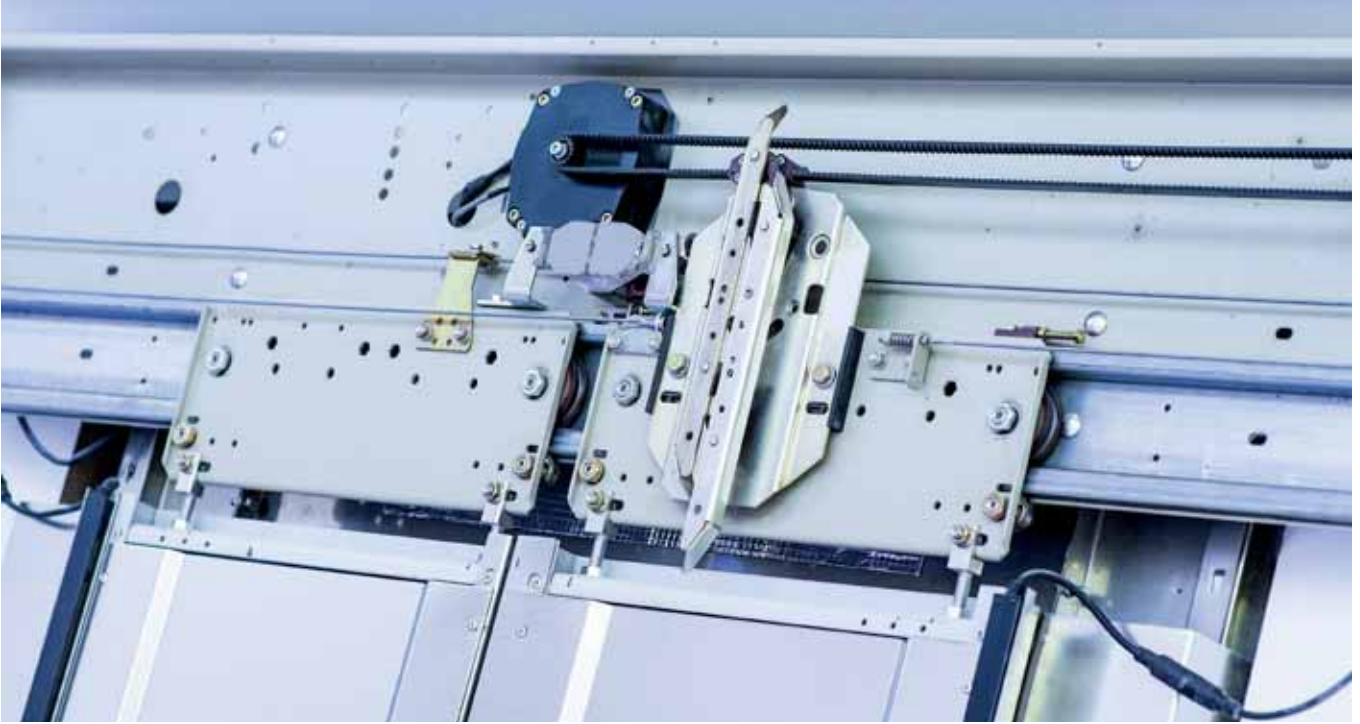

Automatic Doors | Автоматические двери | **Otomatik Kapılar** | ابواب اتوماتيكية



Telescopic 2 Panel Door
Телескопическая 2-х панельная дверь
Teleskopik 2 Panel Kapı
باب تلسكوبي 2 لوحتين



Central 2 Panel Door
Центральная 2-х панельная дверь
Merkezi 2 Panel Kapı
باب مركزي 2 لوحة



Glass Doors
Стеклянные двери
Cam Kapılar
ابواب زجاجية



Automatic Doors | Автоматические двери | Otomatik Kapılar | ابواب اتوماتيكية

Telescopic 3 Panel Door
Телескопическая 3-х панельная дверь
Teleskopik 3 Panel Kapı
باب تلسكوبي 3 لوحات



Central 2 Panel Door
Центральная 2-х панельная дверь
Merkezi 2 Panel Kapı
باب مركزي 2 لوحة



Telescopic 2 Panel Door
Телескопическая 2-х панельная дверь
Teleskopik 2 Panel Kapı
باب تلسكوبي 2 لوحتين



Landing Doors | Посадочные двери | Kat Kapıları | ابواب الهبوط



LPK 101



LPK 102



LPK 103



LPK 104

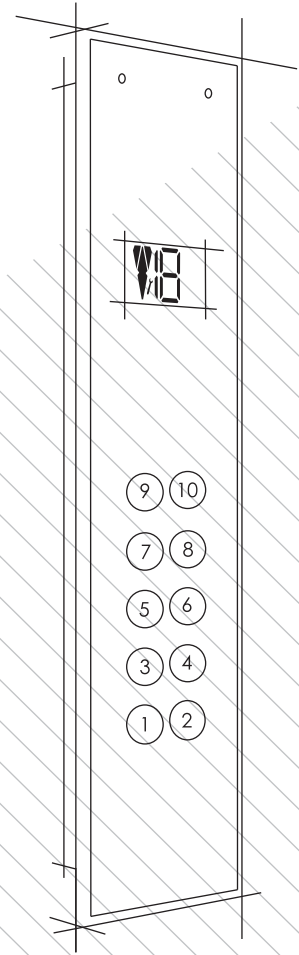



LPB
113



LPB
114



LPB
115



LPB
116



LPB
117



LPB
118



LPB
119



LPB
120



LPB
121



LPB
122



LPB
123



LPB
124



LPB
125



LPB
126



LPB
127



LPB
128



LPB
201



LPB
202



LPB
203



LPB
204



LPB
205



LPB
206



LPB
207



LPB
208



Motor | Двигатель | Motor | محرك

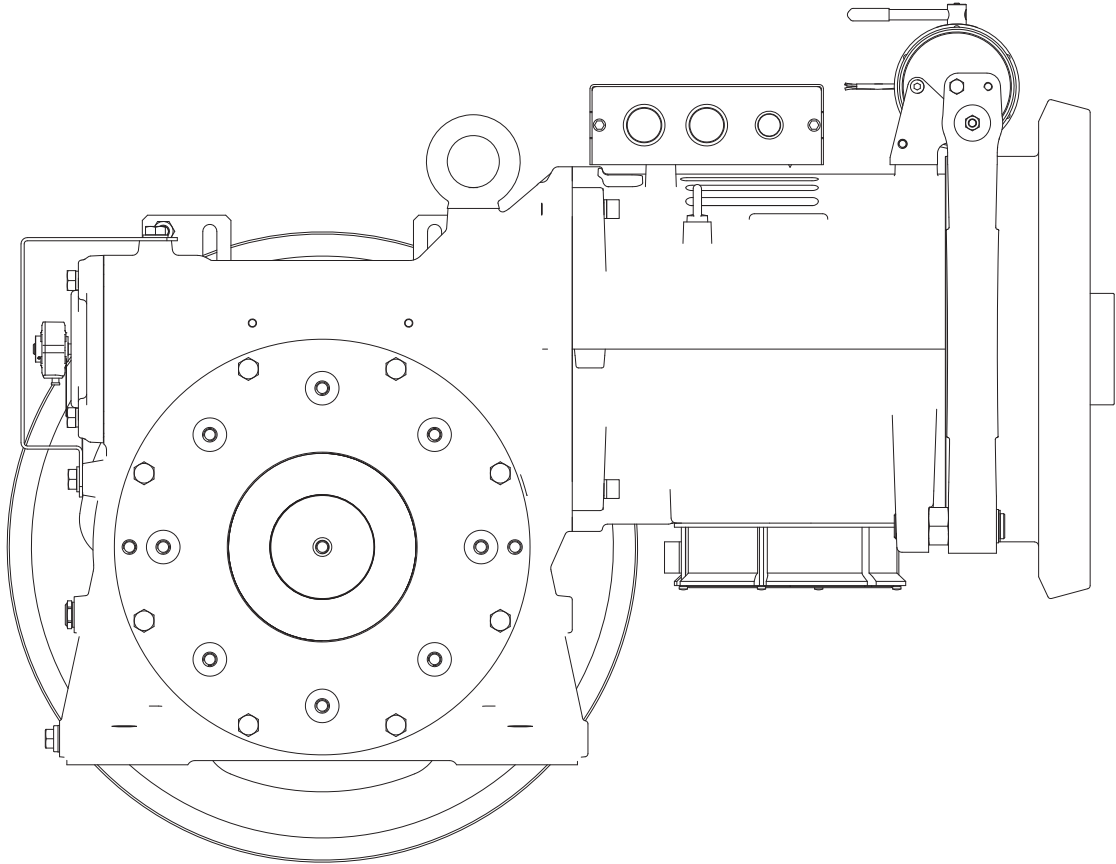

MRL

MR



LP-MRL01



LP-MR11



LP-MRL02



LP-MR12



LP-MRL03



LP-MR13



LP-MRL04



LP-MR14

MRL

MR



LP-MRL05



LP-MR15



LP-MRL06



LP-MR16



LP-MRL07



LP-MR17



LP-MRL08



LP-MRL09



LP-MR10



Elevator Systems | Лифтовые системы
Asansör Sistemleri | أنظمة المصاعد

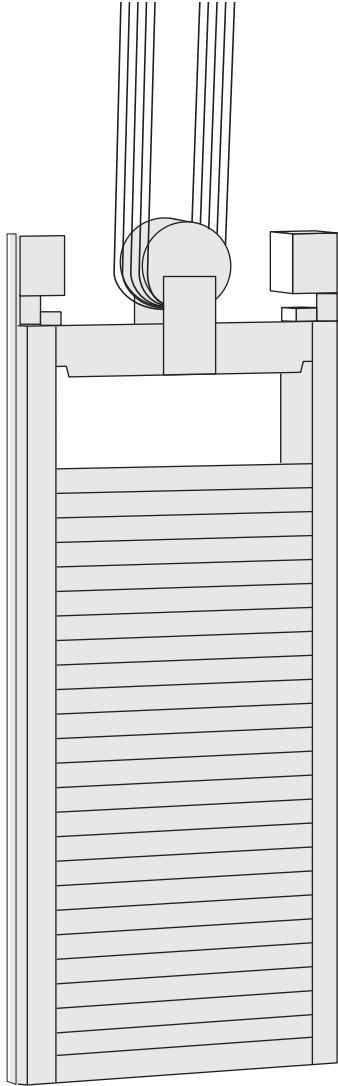



L Cabin Carcass
L каркас кабины
L Kabin Karkaslar
حامل المصعد شكل I.

Machine Carcass | Каркас машины | **Makine Karkasları** | حامل المحرك



Counterweight Carcass
Каркас противовеса
Ağırlık Karkasları
حامل الوزن



C Cabin Carcass
C каркас кабины
C Kabin Karkaslar
حامل الكبينة شكل c



Electric Cabin Carcass
Каркас кабины с электроприводом
Elektrikli Kabin Karkasları
هيكل المقصورة الكهربائية



Adjustable buffer table
Регулируемый буферный стол
Ayarlanabilir Tampon Sehpası
عازل قابل للتعديل



Adjustable buffer table
Регулируемый буферный стол
Ayarlanabilir Tampon Sehpası
عازل قابل للتعديل



Motor table
моторный стол
Motor Sehpası
طاولة المحرك





Options | Опции | Opsiyonlar | خيارات

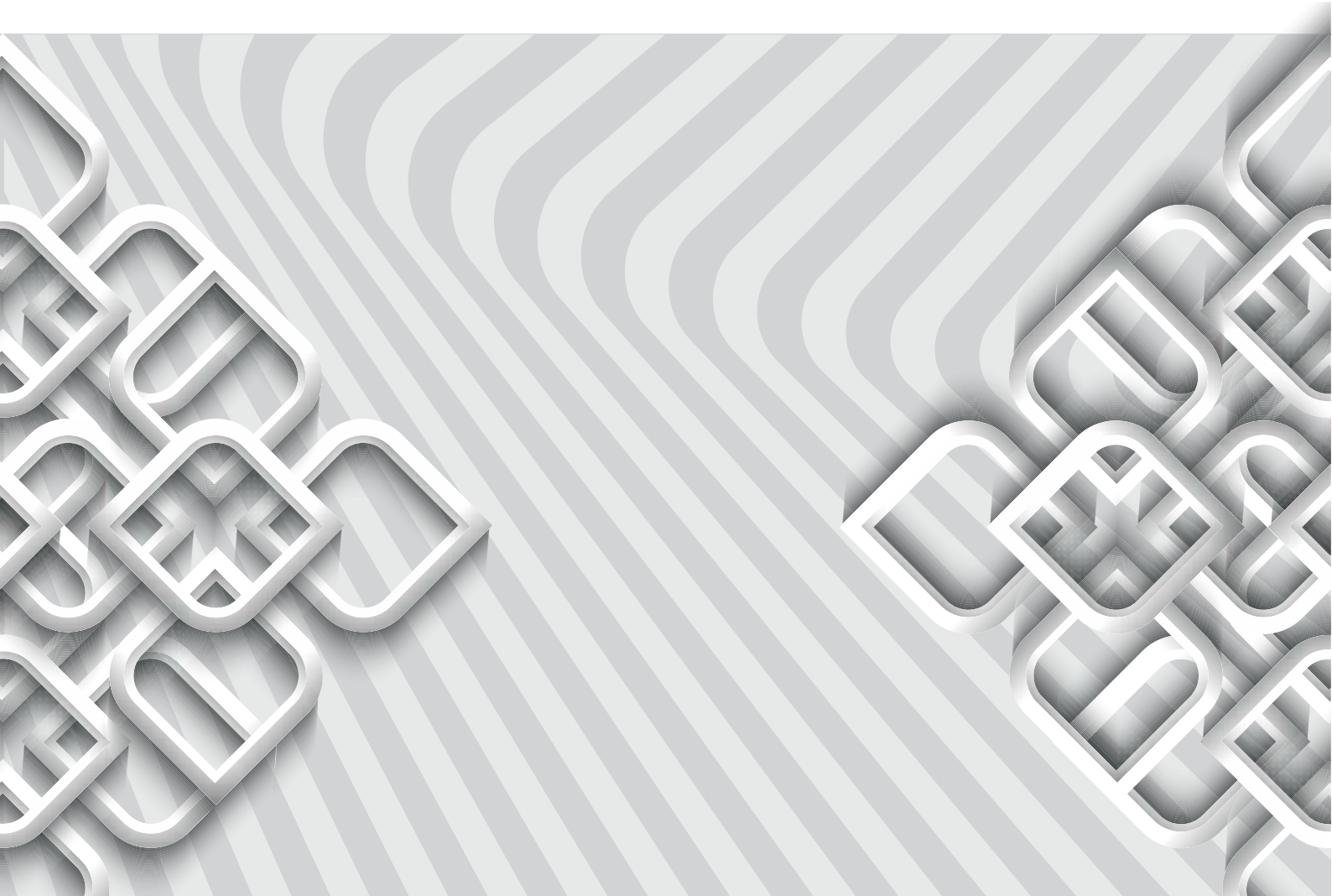



LP - 609



LP - 610



LP - 611



LP - 612

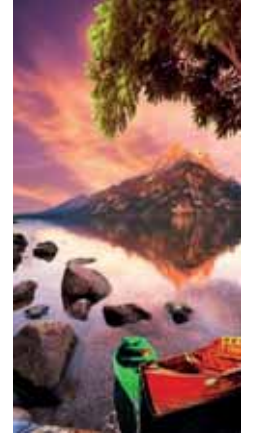

LP - 613

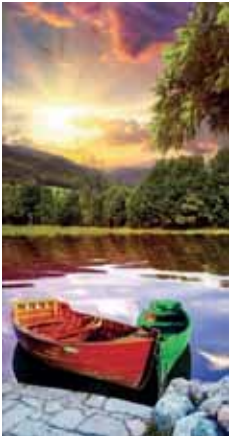

LP - 614



LP - 615



LP - 616



LP - 617



LP - 618



LP - 619



LP - 620



LP - 621



LP - 622



LP - 623



LP - 624



LP - 625



LP - 626

Stainless Options | Нержавеющая | Paslanmaz Seçenekleri | انواع غير قابلة للصدأ



LP - 509



LP - 510



LP - 511



LP - 512



LP - 513



LP - 514



LP - 515



LP - 516



LP - 517



LP - 518



LP - 519



LP - 520



LP - 521



LP - 522



LP - 523



LP - 524



LP - 525



LP - 526



LP - 527



LP - 528



LP - 529



LP - 530

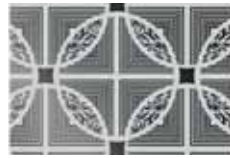

LP - 531



LP - 532



LP - 533



LP - 534



LP - 535



LP - 536



LP - 537



LP - 538



LP - 539



LP - 540



LP - 541



LP - 542

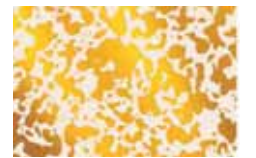

LP - 543

Stone Pavement | Каменный тротуар | Taş Döşeme | أرضيات حجرية



LP - 309



LP - 310



LP - 311



LP - 312



LP - 313

Laminate | ламинат | Laminat | الالواح الخشبية



LP - 409



LP - 410



LP - 411



LP - 412



LP - 413



LP - 414



LP - 415



LP - 416



LP - 417



LP - 418

Membrane | Мембрана | Membran | الواح خشبية



LP - 709



LP - 710



LP - 711



LP - 712

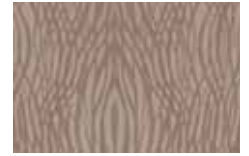

LP - 713



LP - 714



LP - 715



LP - 716



LP - 717



LP - 718

High Gloss | Глянцевый | خشب هاي غلوس



LP - 809



LP - 810



LP - 811



LP - 812



LP - 813

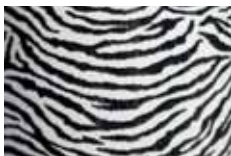

LP - 814



LP - 815



LP - 816



LP - 817



LP - 818



LP - 819



LP - 820



LP - 821



LP - 822



LP - 823



LP - 824



LP - 825



LP - 826



LP - 827



LP - 828

Ceiling | Потолок | Tavan | السقف



LPT - 209



LPT - 210



LPT - 211



LPT - 212



LPT - 213



LPT - 214



LPT - 215



LPT - 216



LPT - 217



LPT - 218



LPT - 219



LPT - 220



LPT - 221



LPT - 222



LPT - 223



LPT - 224



LPT - 225

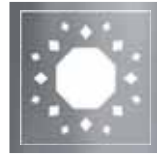

LPT - 226



LPT - 227



LPT - 228



LPT - 229



LPT - 230



LPT - 231



LPT - 232



LPT - 233



LPT - 234



LPT - 235



LPT - 236



LPT - 237



LPT - 238



LPT - 239



LPT - 240



LPT - 241



LPT - 242



LPT - 243

Floor Options | Варианты пола | Zemin Seçenekleri | انواع الارضيات

PVC



LPF - 109



LPF - 110



LPF - 111

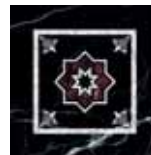

LPF - 112



LPF - 113



LPF - 114

GRANİT



LPF - 115



LPF - 116



LPF - 117



LPF - 118



LPF - 119



LPF - 120



Spare Parts | **Запасные части** | **Yedek Parça** | **قطع الغيار**

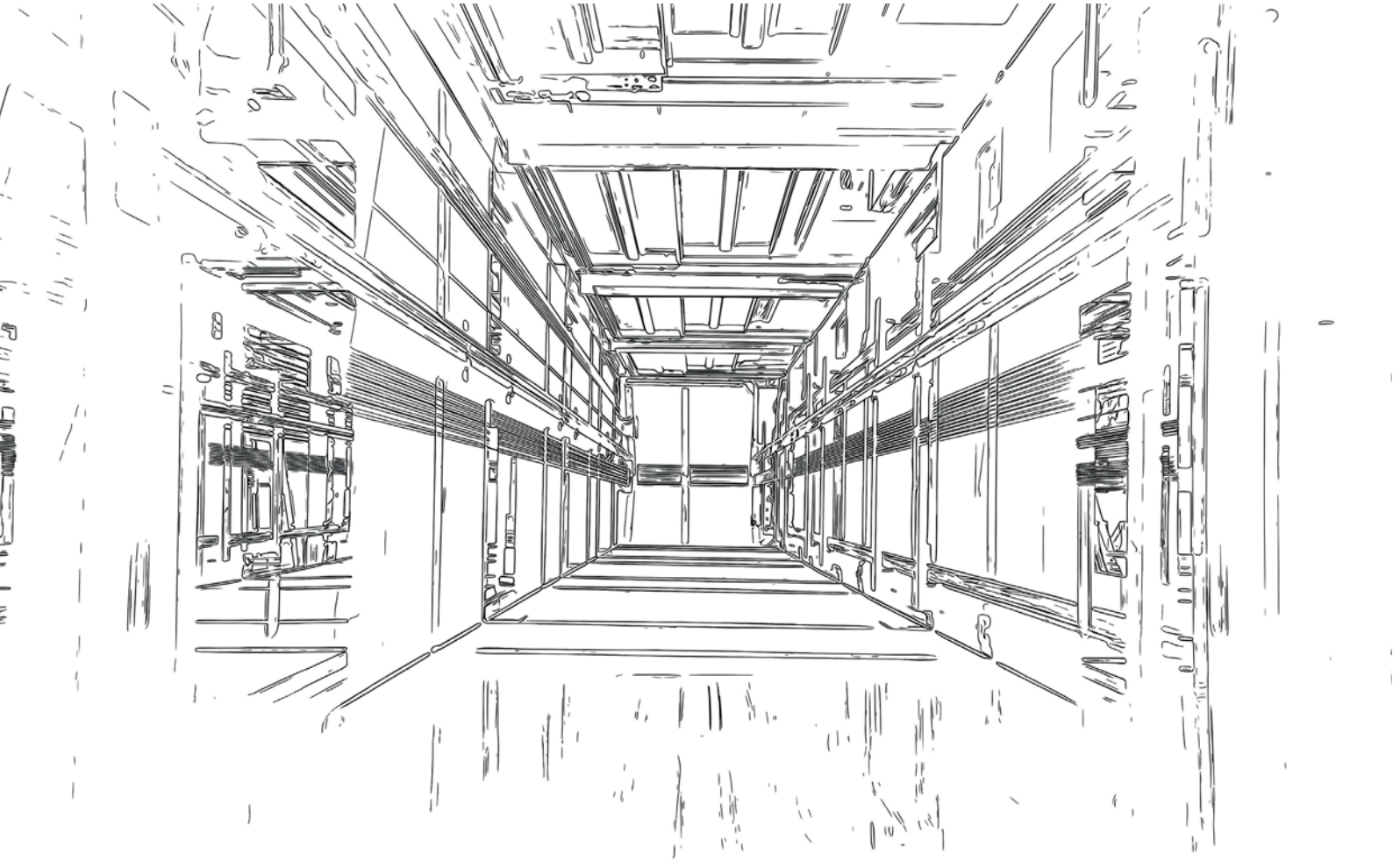



Tensioner



Casting Guide Shoes



Safet Gear



Pit Free Governor



Chain Lock



Chain Roller



Speed Governor Mr



Rope Bottle



Plastic Guide Shoes



Leaf Skate



MRL. Rail Mountd Speed Governor



Rope Collector



Chain Roller Bracket



Balance Chain



Plastic Shoes



Rope Connector



Speed Governor A3



Chain Swivel



Guide Roller



Speed Governor MRL



Steel Rope



Roller Guide Shoes



Plastic Counter Weight Shoes



Fixed Skate Block



Metal Sheet Guide Shoes



Missle



Door Bracket



Brake



Door Motor



Safet Gear L Frame Type

Spare Parts | Запасные части | Yedek Parçalar | قطع الغيار



Casting Nail



Pulleycover For MR



Chrome Handrail



Buffer 25cm



Flexible Wedge



Buffer 15cm



Screwed Cabin Mount



Pulley



Dictator



Fishplate



Buffer 10cm



Bracket



Wedge For Machin Frame



Wedge For Machin Frame



Wedge For Machin Frame



Steel Dowel



Steel Dowel



Lubricator



Nail Metal Sheet



Buffer Base



Door Opening Magnet



Rail



Plastic Baret Weight



Oil Collecting Cup



Plexi Handrail



Rope Hat



Pulleycover For MRL



Stabing Wedge L For Cabin Ceiling



Door Lock



Hydraulic Buffer



Emerg. Stop Boxed Button



Boxed Keyed Button



Boxed Siren



Hand inspection - 5



Revision Pit Box



Boxed Horn



Fire Sensor



Telephone Handset



Contactor



Spring Buttons



Roller Limit Switch



Switch



Switch



Switch



12V - 1.3AH - Battery



Digital Cable



0,75 mm Nyaf Cable



Flexible Cable



TTR | NYAF | NYA - Cable



Longtudinal Photocell



Square Diode



Mono Stable



Bi Stable



UPS Power Supply



12V - 7.0 AH - Battery



250W Transformer



Flashing Siren



Plastic Cable Channel



Steel Channel



Radial Fan

Spare Parts | Запасные части | Yedek Parçalar | قطع الغيار



Terminal



Braking Resistor



Spiral Tube 14 mm



Electricity Distribution Board



Strip Magnet



Cabin Fan



Armature



Led Projector



Led Spot



Tape Armature With Led



Regulator Control Unit



Door Bridging Board

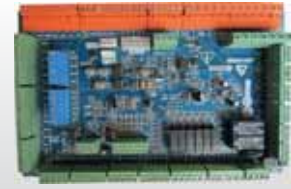

Card Top Control Connection Card



Control Panel Connection Card

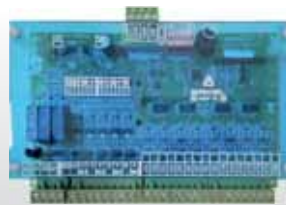

Parallel Comm Board 16 Stop



Audio Warning System



Positioning Sensor



AREM Handle terminal



Leveling Card



Absolute Encoder Card



Pit Connection Block



Incremental Encoder Card

LIFT PORT

ELEVATOR SYSTEMS

 www.liftport.com.tr

 **Panoma**[®]
Asansör Kontrol Sistemleri



ORPAN ELEKTRİK

ORPAN
ELEKTRİK

444 7 065 www.orpanelektrik.com.tr

ELEKTRİK MALZEMELERİ

Şişli

Kent

İstanbul

Yeni

Orpa

Elektrik



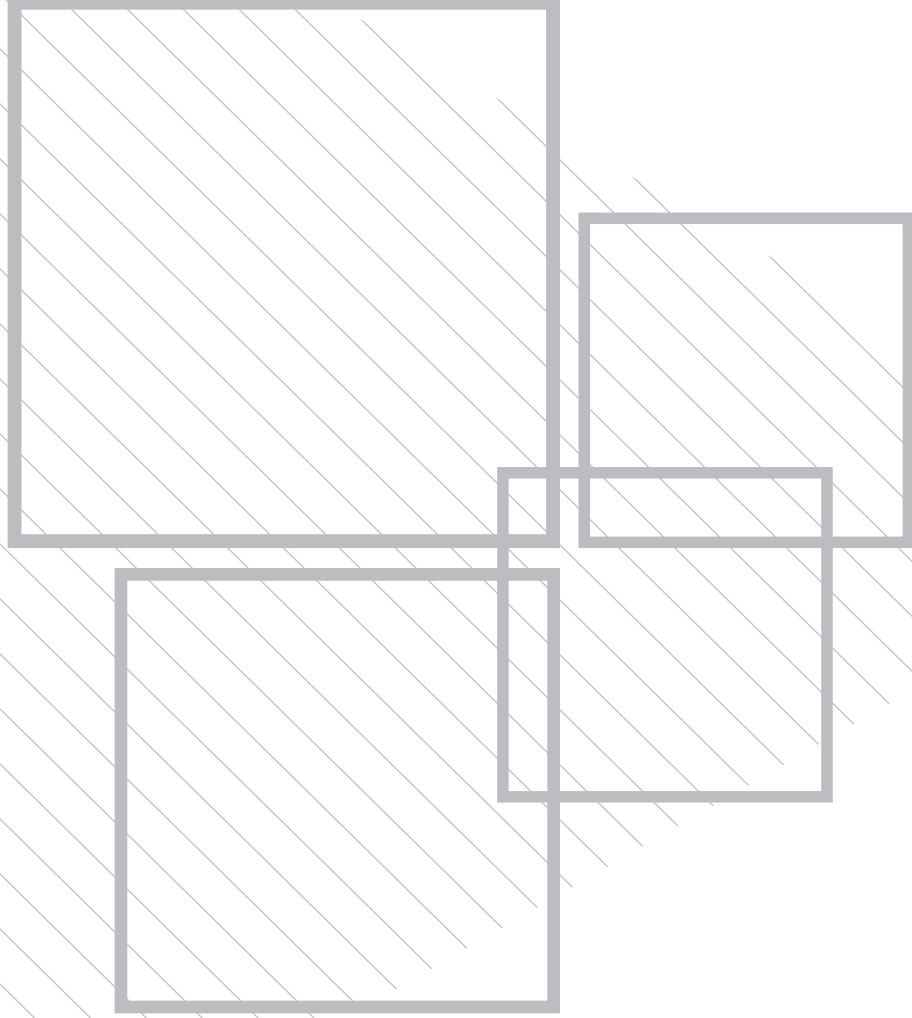

LIFT PORT

LiftPort Asansör Dış Tic. Ltd. Şti.

Fevzi Çakmak Mah. Aslım Caddesi
Kobisan 1.Sanayi Sitesi No:67/D Karatay / KONYA

T: +90 332 235 PANO(7266) **F:** +90 332 236 PANO (7266)

E: info@liftport.com.tr

MEGATON
MEDYA VE İNFORMASYON TEKNOLOJİLERİ